

RLC-CLUB Repeater, Link and Remote Base Controller

Software Version 1.77

Copyright 1997, All Rights Reserved

Link Communications, Inc.

P.O. Box 1071

115 Second Ave N.E.

Sidney, MT 59270

(406) 482-7515 Voice

(406) 482-7547 Fax

<http://www.link-comm.com>

Introduction:

Congratulations, you have purchased a very powerful tool for your group's repeater. The RLC-Club is a small yet powerful control system for your groups repeater needs. With the included Windows™ programming software, the 'Club' is easy to get programmed and operational. Setting it up and programming it are easy and straightforward, once you have read the manual. Please take the time to read it before you try to start programming. This will save you a lot of confusion and frustration, as it should answer most of your questions.

The RLC-Club repeater, link and remote base controller supports up to 2 radio ports, 4 analog voltage inputs and 8 output drivers. The radio ports can be configured to require one of several combinations of COR and PL inputs for access. The RLC-Club has a DTMF decoder per radio port, thereby supporting DTMF control from all radio ports of the controller. Synthesized voice prompts the users in the programming of the controller's variables, provides voice ID's and alarms based on the inputs, etc. The autopatch includes 500 programmable autodial numbers, cover tone, directed reverse patch and telephone control. DVR, HF and VHF/UHF remote base support. All command codes, timer values, and messages are programmable by owner. Each message can contain combinations of Morse code characters, synthesized speech words, sound effects, DVR tracts, etc. The controller can be programmed using DTMF from any of the radio ports, using DTMF from a telephone (using the reverse autopatch), or from a computer using a serial cable or modem. The controller contains several hundred command macros.. There is a clock/calender time chip with internal battery backup for years of non-interrupted time piece operation. The timed event scheduler can be used to automatically load configurations based on time of day and day of week settings. All input, output, analog and radio interfacing signals can be assigned automatic event calls to allow unattended functional operations.

This manual consists of three main sections: setup and interfacing, programming and commands, and the appendices with commonly referenced tables and charts. A glossary has also been included at the end to explain some of the terms and abbreviations that are used throughout the manual.

We have attempted to explain everything in a way that is easy to understand, but some questions are inevitable. If you have carefully read the manual and still have questions, call us at (406) 482-7515, fax us at (406) 482-7547, e-mail us at support@link-comm.com or write to us at

Link Communications Inc.
115 Second Ave N.E.
P.O. Box 1071
Sidney, MT 59270

Table of Contents

Command List by Number	xiii
Limited Warranty	xvii
Regulatory Information	xviii
Telephone Grounding Precautions:	xviii
User Survey (Optional)	xix
Chapter 1: Getting Started	1-1
Setup, Interfacing and Adjustment	1-1
What Each Connector is For	1-1
What the LED's Represent:	1-2
Serial Port Interfacing	1-8
Windows™ Programming	1-12
Installation:	1-12
Operation:	1-12
Limitations:	1-12
Reset and Power Up	1-13
Entering Commands	1-13
Error Messages	1-15
How to Configure a Port as a Repeater	1-17
Example 1-1: Configuring a Port as a Repeater, Link	1-18
Example 1-2: Configuring a Port's COR/PL Polarity	1-19
Troubleshooting the Controller	1-20
Chapter 2: Port Connection Commands	2-1
"Connected Ports"	2-1
Turning a Repeater Off	2-1
000: Connect one Port to another Port	2-4
001: Monitor one Port from another Port	2-5
002: Disconnect one Port from another Port	2-6
003,004: Recall a Port's Connections	2-7
005: Set Receiver and DTMF Decoder Conditions	2-8
006: Recall Receiver and DTMF Decoder Conditions	2-10
009: Recall Entire Controller's Audio Crosspoint	2-11
013: Set COR and PL Active Levels	2-12
061: Disconnect all Ports from a Radio Port	2-13
155: Enable or Disable PTT for a Port	2-14
156: Recall Which PTT are Enabled	2-14
Chapter 3: Audio and DTMF configurations	3-1
007: Configure DTMF Mute/Cover Tone/Bypass	3-3
008: Check DTMF Mute/Cover Tone/Bypass Settings	3-4

Chapter 4: Timers	4-1
020: Program a Selected Timer	4-2
021: Recall a Timer Value	4-14
022: Start a Timer	4-14
023: Stop a Timer	4-14
025: Sets the Time of Day Clock	4-15
026: Recall the Time of Day Clock in Male Speech	4-15
027: Recall the Time of Day Clock in Female Speech	4-16
028: Sets the Date	4-17
029: Recall the Date	4-18
Chapter 5: Command Names	5-1
How Command Names and Command Numbers are Used:	5-1
010: Re-Program Command Names	5-5
062: Change the Beginning of Command Names	5-7
011: Recall Command Name	5-8
012: Find Commands Named	5-8
Blocking Execution from Certain Ports	5-9
130: Block Command Execution From Port	5-10
131: Allow Command Execution From Port	5-10
132: Recall Blocked Ports	5-10
Chapter 6: CW, DTMF, Voice and DVR Messages	6-1
030: Send a CW Message	6-2
031: Send a DTMF Sequence	6-3
036: Send a Voice Message	6-4
066: Send a Voice Message Using English Words	6-4
040: Send One or Two Tone Sequence	6-5
Note about Courtesy Beeps	6-6
041: Courtesy Beep Enable/Disable for a Selected Transmitter	6-8
042: Set CW Speed for a Selected Port	6-9
043: Set CW 2-Tone Frequencies for a Selected Port	6-10
044: Set Up DTMF Regenerate Parameters	6-11
051: Start Dial-Tone	6-11
063: Send a Polite Voice Message	6-12
064: Send a Polite Voice Msg, If Interrupted Execute Cmd	6-13
163: Keypad Test	6-14
The DVR1 Digital Voice Recorder	6-15
What the DVR1 is:	6-15
182: Enable/Disable RLC-DVR1	6-22
170: Record and Play Audio Test	6-22
171: Record DVR Track (non-prompted)	6-22
172: Record DVR Track (prompted)	6-23
173: Play DVR Tracks	6-23
174: Erase DVR Tracks	6-24
175: Record Public Mail	6-25
176: Check Public Mailboxes	6-25
177: Retrieve Public Mail	6-25



178: Erase Public Mail	6-26
179: Record Private Mail	6-26
180: Retrieve Private Mail	6-26
181: Erase Private Mail	6-27
The Internal Digital Voice Recorder	6-28
183: Record a Message on the Internal DVR	6-29
184: Playback an Internal DVR Message(s)	6-30
185: Erase Internal DVR Message(s)	6-30
052: Audio Test using the Internal DVR	6-31
034: Adjust each Port's Internal DVR Record Level	6-32
Chapter 7: Serial Port Commands	7-1
024: Set Up RS-232 Serial Baud Rate	7-3
060: Set Up Serial Port Options	7-4
032: Send Serial Message	7-5
162: Always Send Serial Message out the Main Serial Port	7-5
169: Always Send Serial out Main Serial Port by ASCII Code	7-6
138: Direct SPI Send using Output Lines	7-7
Chapter 8: Macros	8-1
How Macros Get Executed:	8-1
What a macro is:	8-1
Limits on Macros:	8-2
200..499: Execute a Macro	8-4
053: Program a Single Command Macro Sequence	8-5
054: Recall Macro Contents	8-6
055: Delete Macro	8-7
056: Append a Command to a Macro	8-7
057: Copy a Macro	8-7
058: Delete a Command in a Macro	8-8
059: Insert a Command in a Macro	8-8
Automatic Macros	8-9
Chapter 9: Pre-Access Commands	9-1
What preaccess is:	9-1
What you need to know:	9-1
049: Configure a Port's Tone Response when in Preaccess	9-2
070: Configure a Repeater for Preaccess	9-3
071: Configure a Link for Preaccess	9-4
072: Disable Preaccess Requirement for a Port	9-5
073: Recall Ports with Preaccess Requirement	9-5
074: Allow Access To a Port that Requires Preaccess	9-5
075: Set Stop Access Conditions	9-6
076: Recall Stop Access Conditions	9-7
077: Isolate a Port from the Rest of the System	9-7

Chapter 10: Scheduler	10-1
How the Scheduler Works:	10-1
082: Set Up a Scheduler Event	10-2
083: Recall a Scheduler Event	10-5
084: Enable/Disable a Scheduler Event	10-6
Chapter 11: The ID System	11-1
How the ID's Work:	11-1
Polite Voice ID's:	11-1
To Program Your Own ID's:	11-2
More about Programming ID's:	11-2
ID Timing:	11-3
085: Enable/Disable IDing a Port	11-4
086: Recall Which Ports have ID's Enabled	11-4
087: Set Random or Rotating Pending ID's	11-5
088: Recall Random or Rotating Pending ID Selection	11-5
Chapter 12: I/O System	12-1
About the I/O System:	12-1
Logical Output Lines	12-1
Analog Input Lines	12-1
Inputs Connector Pin-Out	12-3
090: Read Whether Input Line is High or Low	12-4
091: Execute Input Line High or Low Macro	12-4
092: Enable/Disable Input Line Alarm	12-5
093: Turn Output Line On	12-6
094: Turn Output Line Off	12-6
095: Recall Whether Output Line is On or Off	12-7
100: Read Analog Input Line	12-8
101: Set Resolution For Analog Input	12-9
102: Set Conversion Ratio For Analog Input	12-11
Custom Analog Conversion Ratios:	12-12
103: Calibrate an Analog Input	12-14
104: Set an Analog Alarm	12-15
105: Set Analog Alarm Hysteresis	12-16
106: Enable/Disable an Analog Alarm	12-18
107: Recall Analog Lines in Alarm	12-18
108: Recall Analog Line Configuration	12-19
160: Clear Analog High/Lows	12-20
161: Set Analog Smoothing Factor	12-21
109: Configure Wind Speed Reading	12-22
Chapter 13: Autopatch Routines	13-1
Configuring the Autopatch:	13-1
Autopatch Up Commands:	13-1
Using '*' for the Autopatch Up Command:	13-1
Hanging Up:	13-2
Connected Ports:	13-2

Predial Digits:	13-2
The Autodialer:	13-2
Limiting Call Length:	13-3
How the Dialing Tables Work:	13-3
Other Commands that Affect the Autopatch:	13-4
110: Configure the Autopatch	13-6
111: Manual Off Hook	13-7
112: Normal Forward Dial	13-7
113: Forward Dial with no Long Distance Checking	13-8
114: Hang up the Autopatch	13-9
115: Possibly Hang up the Autopatch	13-9
116: Set / Recall the Predial Digits and Timing	13-10
119: Set Allowed Numbers Table Slot	13-11
120: Recall Allowed Numbers Table Slot	13-11
121: Set Nuisance Numbers Table Slot	13-12
122: Recall Nuisance Numbers Table Slot	13-12
123: Test Dialing Tables	13-13
124: Set Autodial Slot	13-14
125: Recall Autodial Slot	13-14
126: Send Predial Digits / Callsign for Autodial Slot?	13-15
127: Enable/Disable an Autodial Slot	13-15
128: Set Full or Half-Duplex Patch Audio for a TX	13-16
129: Recall Full or Half-Duplex Patch Audio for a TX	13-16
133: Set up Reverse Patch	13-17
134: Access Reverse Patch Control Mode	13-18
135: Answer Reverse Patch	13-18
136: Set up Reverse Autopatch Ring	13-19
137: Autodial Only	13-19

Chapter 14: Doug Hall RBI-1 and RLC-ICM Routines	14-1
What the RBI-1 is:	14-1
What the RLC-ICM is:	14-1
Interfacing and Setup:	14-1
Using the RBI-1 or RLC-ICM:	14-2
Building the RBI-1/RLC-ICM Cable	14-5
139: Set Up the RLC-Icom Interface	14-8
RLC-ICM Internal Operation Test Points	14-11
141: Set Band Unit for RBI-1 or RLC-ICM	14-12
142: Set Frequency (and Offset) for RBI-1 or RLC-ICM	14-13
143: Set Offset for RBI-1 or RLC-ICM	14-14
144: Set Offset and Frequency Readback Styles	14-15
145: Set Power Level for RBI-1	14-16
146: Set PL Frequency for RBI-1 or RLC-ICM	14-17
147: Turn PL Encode Off/On for RBI-1 or RLC-ICM	14-18
148: Turn PL Decode Off/On for RBI-1 or RLC-ICM	14-18
149: Recall Band, Frequency& Offset for RBI-1 or RLC-ICM	14-19
150: Recall All RBI-1 or RLC-ICM Settings	14-19

151: Turn Radio Power On or Off for RBI-1	14-20
152: Goto Radio Memory Channel for the RBI-1	14-21
Chapter 15: Serial Controlled (HF) Radio Support	15-1
HF Radio Interfacing	15-1
HF Radio Control:	15-2
195: Configure HF Mode	15-4
196: Configure HF Radio	15-5
197: Set/Recall Transmit/Scan Band Edges	15-7
198: HF Mode Enable	15-9
HF Remote Base Keypad Definition:	15-10
199: Enter HF Command (w/o being in HF mode)	15-16
Chapter 16: Special Audio Routing Commands	16-1
037: Set Audio Routing Variable for Commands In a Macro	16-2
038: Kill All Responses Following This Command	16-3
065: Restore Audio Routing Variable (Undo 037 and 038)	16-4
039: Recall the Ports in the Current Audio Routing Variable	16-5
050: Set Up or Recall Default Audio Routing Variables	16-6
Chapter 17: Special Control Commands	17-1
035: Remotely Reset the Controller	17-2
078: Set Command Entry Options for a Port	17-3
079: Recall Command Entry Options for a Port	17-5
080: Execute Command by Number	17-6
164: Recall Software Version	17-8
165: Reset COP Watchdog Timer	17-8
166: Display Status Screen	17-9
167: Do Nothing	17-9
014..019: Not Currently Used	17-10
033, 034: Not Currently Used	17-10
067..069: Not Currently Used	17-10
081, 081: Not Currently Used	17-10
089: Not Currently Used	17-10
096..099: Not Currently Used	17-10
109: Not Currently Used	17-10
117..118: Not Currently Used	17-10
140: Not Currently Used	17-10
153..154: Not Currently Used	17-10
168: Not Currently Used	17-10
192..194: Not Currently Used	17-10
197: Not Currently Used	17-10
Chapter 18: 500 User Structure	18-1
The Password System	18-1
Method #1 - No Passwords:	18-3
Method #2 - Fixed Passwords:	18-3
Method #3 - Challenge Passwords:	18-4

Method #4 - Challenge Passwords with Decoy Digits:	18-5
186: Set up User Password	18-6
187: User Log-on	18-7
188: Recall Who Is Logged In	18-8
189: User Log-off	18-8
190: Assign a User Level to a Command	18-9
191: Assign a Callsign to a User	18-10
Chapter 19: The Beacons System	19-1
045: Setup Beacon Table	19-2
046: Start Beacon	19-3
047: Cancel Beacon	19-3
048: Start Beacon Using English Words	19-4
Chapter 20: Event Triggers	20-1
157: Set Up Event Trigger	20-2
158: Recall Event Trigger Setting	20-2
159: Enable/Disable Event Trigger	20-2
Appendix A: The Audio Routing Variable System	A-1
Explanation of the System	A-1
Suppressing Command Responses in Macros:	A-2
Appendix B: Voice Word Table	B-1
Appendix C: CW Code Table	C-1
Appendix D: Reset and Initialization	D-1
Appendix E: Not Currently Used	E-1
Appendix F: Programming with the Serial Port	F-1
Voice responses to commands entered serially:	F-2
Using a serial upload file:	F-2
Note about spaces in serial commands:	F-3
Note about comments in serial upload files:	F-3
Note about capital letters:	F-3
Note about download speeds:	F-3
Serial responses to commands entered from a radio:	F-4
Very Long Serial Commands:	F-4
Appendix G: ASCII Chart	G-1
Appendix H: Using the LM335 Temperature Sensor	H-1
Appendix I: Software Problem and Request Form	I-1
Appendix J: Hardware Reference Section	J-1

Important Connections:	J-1
RLC-Club Main Board	J-1
RLC-Club Deluxe Module	J-2
Bill of Materials	J-3
RLC-Club Controller	J-3
RLC-Club Deluxe	J-8
Component Layouts and Schematic Diagrams	J-11

Command List by Number

000: Connect one Port to another Port	2-4
001: Monitor one Port from another Port	2-5
002: Disconnect one Port from another Port	2-6
003,004: Recall a Port's Connections	2-7
007, 008: Configure, Check DTMF Mute on a Selected Port	3-3, 3-4
009: Recall Entire Controller's Audio Crosspoint	2-11
010: Re-Program Command Names	5-5
011, 012: Recall Information about a Command Name	5-8
013: Set COR and PL Active Levels	2-12
014..019: Not Currently Used	17-10
020: Program a Selected Timer	4-2
022: Start a Timer	4-14
023: Stop a Timer	4-14
024: Set Up RS-232 Serial Baud Rate	7-3
025: Sets the Time of Day Clock	4-15
026: Recall the Time of Day Clock in Male Speech	4-15
027: Recall the Time of Day Clock in Female Speech	4-16
028: Sets the Date	4-17
029: Recall the Date	4-18
030: Send a CW Message	6-2
031: Send a DTMF Sequence	6-3
032: Send Serial Message	7-5
033, 034: Not Currently Used	17-10
034: Adjust each ports Internal DVR Record Level	6-32
035: Remotely Reset the Controller	17-2
036: Send a Voice Message	6-4
037: Set Audio Routing Variable for Commands In a Macro	16-2
038: Kill All Responses Following This Command	16-3
039: Recall the Ports in the Current Audio Routing Variable	16-5
040: Send One or Two Tone Sequence	6-5
041: Courtesy Beep Enable/Disable for a Selected Transmitter	6-8
042: Set CW Speed for a Selected Port	6-9
043: Set CW 2-Tone Frequencies for a Selected Port	6-10
044: Set Up DTMF Regenerate Parameters	6-11
045: Setup Beacon Table	19-2
046: Start Beacon	19-3
047: Cancel Beacon	19-3
048: Start Beacon Using English Words	19-4
049: Configure a Port's Tone Response when in Preaccess	9-2
050: Set Up or Recall Default Audio Routing Variables	16-6
051: Start Dial-Tone	6-11
052: Audio Test using the Internal DVR	6-31
053: Program a Single Command Macro Sequence	8-5
054: Recall Macro Contents	8-6
055: Delete Macro	8-7
056: Append a Command to a Macro	8-7

057: Copy a Macro	8-7
058: Delete a Command in a Macro	8-8
059: Insert a Command in a Macro	8-8
060: Set Up Serial Port	7-4
061: Disconnect all Ports from a Radio Port	2-13
062: Change the Beginning of Command Names	5-7
063: Send a Polite Voice Message	6-12
064: Send a Polite Voice Message and if Interrupted...	6-13
065: Restore Audio Routing Variable (Undo 037 and 038)	16-4
066: Send a Voice Message Using English Words	6-4
067..069: Not Currently Used	17-10
070: Configure a Repeater for Preaccess	9-3
071: Configure a Link for Preaccess	9-4
072: Disable Preaccess Requirement for a Port	9-5
073: Recall Ports with Preaccess Requirement	9-5
074: Allow Access To a Port that Requires Preaccess	9-5
075: Set Stop Access Conditions	9-6
076: Recall Stop Access Conditions	9-7
077: Isolate a Port from the Rest of the System	9-7
078: Set up Force-Execution Functions for a Port	17-3
079: Recall Force-Execution Set up's for a Port	17-5
080: Execute Command by Number	17-6
081, 081: Not Currently Used	17-10
082: Set Up a Scheduler Event	10-2
083: Recall a Scheduler Event	10-5
084: Enable/Disable a Scheduler Event	10-6
085: Enable/Disable IDing a Port	11-4
086: Recall Which Ports have IDs Enabled	11-4
087: Set Random or Rotating Pending IDs	11-5
088: Recall Random or Rotating Pending ID Selection	11-5
089: Not Currently Used	17-10
090: Read Whether Input Line is High or Low	12-4
091: Execute Input Line High or Low Macro	12-4
092: Enable/Disable Input Line Alarm	12-5
093: Turn Output Line On	12-6
094: Turn Output Line Off	12-6
095: Recall Whether Output Line is On or Off	12-7
096..099: Not Currently Used	17-10
100: Read Analog Input Line	12-8
101: Set Resolution For Analog Input	12-9
102: Set Conversion Ratio For Analog Input	12-11
103: Calibrate an Analog Input	12-14
104: Set an Analog Alarm	12-15
105: Set Analog Alarm Hysteresis	12-16
106: Enable/Disable an Analog Alarm	12-18
107: Recall Analog Lines in Alarm	12-18
108: Recall Analog Line Configuration	12-19
109: Not Currently Used	17-10
109: Configure Wind Speed Reading	12-22

110: Configure the Autopatch	13-6
111: Manual Off Hook	13-7
112: Normal Forward Dial	13-7
113: Forward Dial with no Long Distance Checking	13-8
114: Hang up the Autopatch	13-9
115: Possibly Hang up the Autopatch	13-9
116: Set / Recall the Predial Digits and Timing	13-10
117..118: Not Currently Used	17-10
119: Set Allowed Numbers Table Slot	13-11
120: Recall Allowed Numbers Table Slot	13-11
121: Set Nuisance Numbers Table Slot	13-12
122: Recall Nuisance Numbers Table Slot	13-12
123: Test Dialing Tables	13-13
124: Set Autodial Slot	13-14
125: Recall Autodial Slot	13-14
126: Send Predial Digits / Callsign for Autodial Slot?	13-15
127: Enable/Disable an Autodial Slot	13-15
128: Set Full or Half-Duplex Patch Audio for a TX	13-16
129: Recall Full or Half-Duplex Patch Audio for a TX	13-16
130: Block Command Execution From Port	5-10
131: Allow Command Execution From Port	5-10
132: Recall Blocked Ports	5-10
133: Set up Reverse Patch	13-17
134: Access Reverse Patch Control Mode	13-18
135: Answer Reverse Patch	13-18
136: Set up Reverse Autopatch Ring	13-19
137: Autodial Only	13-19
138: Direct SPI Send using Output Lines	7-7
139: Setup RLC-Icom Interface	14-8
140: Not Currently Used	17-10
141: Set Band Unit for RBI-1 or RLC-ICM	14-12
142: Set Frequency (and Offset) for RBI-1 or RLC-ICM	14-13
143: Set Offset for RBI-1 or RLC-ICM	14-14
144: Set Offset and Frequency Readback Styles	14-15
145: Set Power Level for RBI-1	14-16
146: Set PL Frequency for RBI-1 or RLC-ICM	14-17
147: Turn PL Encode Off/On for RBI-1 or RLC-ICM	14-18
148: Turn PL Decode Off/On for RBI-1 or RLC-ICM	14-18
149: Recall Band, Frequency and Offset for RBI-1 or RLC-ICM	14-19
150: Recall All RBI-1 or RLC-ICM Settings	14-19
151: Turn Radio Power On or Off for RBI-1	14-20
152: Goto Radio Memory for RBI-1	14-21
153..154: Not Currently Used	17-10
155: Enable or Disable PTT for a Port	2-14
156: Recall Which PTT are Enabled	2-14
157: Set Up Event Trigger	20-2
158: Recall Event Trigger Setting	20-2
159: Enable/Disable Event Trigger	20-2
160: Clear Analog High/Lows	12-20

161: Set Analog Smoothing Factor	12-21
162: Always Send Serial Message out the Main Serial Port	7-5
163: Keypad Test	6-14
164: Recall Software Version	17-8
165: Reset COP Watchdog Timer	17-8
166: Display Status Screen	17-9
167: Do Nothing	17-9
168: Not Currently Used	17-10
169: Always Send Serial out Main Serial Port by ASCII Code	7-6
170: Record and Play Audio Test	6-22
171: Record DVR Track (non-prompted)	6-22
172: Record DVR Track (prompted)	6-23
173: Play DVR Tracks	6-23
174: Erase DVR Tracks	6-24
175: Record Public Mail	6-25
176: Check Public Mailboxes	6-25
177: Retrieve Public Mail	6-25
178: Erase Public Mail	6-26
179: Record Private Mail	6-26
180: Retrieve Private Mail	6-26
181: Erase Private Mail	6-27
182: Enable/Disable RLC-DVR1	6-22
183: Record a Message on the Internal DVR	6-29
184: Playback an Internal DVR Message(s)	6-30
185: Erase Internal DVR Message(s)	6-30
186: Set up User Password	18-6
187: User Log-on	18-7
188: Recall Who Is Logged In	18-8
189: User Log-off	18-8
190: Assign a User Level to a Command	18-9
191: Assign a Callsign to a User	18-10
192..194: Not Currently Used	17-10
195: Configure HF Mode	15-4
196: Configure HF Radio	15-5
197: Not Currently Used	17-10
197: Set/Recall Transmit/Scan Band Edges	15-7
198: HF Mode Enable	15-9
199: Enter HF Command (w/o being in HF mode)	15-16
200..499: Execute a Macro	8-4

Limited Warranty

COVERAGE:

Link Communications, Inc. warrants that its products will be free from defects in materials and workmanship for a period of one year from the date of shipment. During this time, Link Communications, Inc. will cover parts, labor and return shipping. If failure is caused by instances other than manufacturing defects, Link Communications, Inc. will repair the product and bill the customer for parts and labor. Contact Link Communications, Inc. for more information.

What Link Communications, Inc. will not cover:

1. Too much voltage to the controller. The RLC-Club operates at +11V to +15V, negative ground.
2. Damage to the controller by lightning, accident, or incorrect power hook-up.
3. Incorrect unit installation.
4. Damage caused by shipment (damage claims are handled by the carrier).
6. Repairs by other than Link Communications, Inc.

THIS WARRANTY HOLDS ONLY TO THE ORIGINAL PURCHASER

HOW TO GET SERVICE

Please contact Link Communications, Inc. for servicing information and authorization.

SOFTWARE

Link Communications, Inc. holds the copyright on the RLC-Club's software and hardware. Changes to the software, copying of the software, and use of the voice code is prohibited without the written consent of Link Communications, Inc.

SOFTWARE UPDATES

Link Communications, Inc. will provide FREE Software updates for 6 months from the date of purchase. The owner must return replaced software chips to Link Communications, Inc. in order to obtain further software updates. Software updates costs will be determined at the release of the update. Manual inserts and shipping are additional.

Regulatory Information

Federal Communications Commission (FCC) Regulations:

To comply with FCC regulations, the following requirements must be met:

- The FCC Registration Number of this device and Ringer Equivalence Number (0.7B), if requested by the telephone company, must be reported. This information is attached to a label found the bottom of this device.
- The sum of Ringer Equivalence Numbers for all devices connected to a single telephone line should not exceed 5 for reliable operation.
- This device must not be installed on coin-operated telephone lines or party lines.
- This device complies with Part 15 of the FCC Rules. Operation is subject to the following two conditions:
(1) this device may not cause harmful interference, and
(2) this device must accept any interference received, including interference that may cause undesired operation.
- Repair work on this device must be done by **Link Communications, Inc.** or an authorized repair station.

Made in the U.S.A

Telephone Grounding Precautions:

The autopatch interface on the 'RLC-Club' contains a 3 pole SIDACTor™ that is used to provide surge and lightning protection to the circuits of the controller. You will notice that there is a separate ground terminal provided. This terminal must be connected to an external earth ground to provide the controller with the designed protection. Do not connect this ground to your power supply ground terminal. Connection to the power supply ground can damage both the controller and the power supply incase of a surge/lightning strike on the phone lines.

The autopatch provides 2 fuses (500mA) in series with the phone line (F3 is series with the telephone TIP, and F2 is series with the telephone RING circuits). If either or both of the fuses blow, a surge/lightning incident has occurred. Only replace the fuses with 500mA, pico fuses. If larger fuses are used, damage to the controllers telephone interface can occur. UL1459 regulations require the fuses, so don't bypass them.

SIDACTor™ is a registered trademark of Teccor Electronics, Inc.

User Survey (Optional)

A knowledge of the user base will allow us to better serve you in the future by helping us develop more specialized software and hardware. Please take a few minutes and fill out this questionnaire.

RLC-Club Serial Number _____

(Located in the upper right corner on the 'Club' board)

RLC-Club Purchase Date _____

Application: (Circle All That Apply)

Ownership:

- 1 - Privately Owned Repeater
- 2 - Club Owned Repeater
- 3 - Group Owned Repeater
- 4 - Commercial Business Repeater
- 5 - Other _____

Installation:

- 1 - Wide Coverage Repeater with Chain Links
 - Port to Port Linking
- 2 - Full Duplex Links
- 3 - Half Duplex Links
- 4 - VHF Repeater: Power _____ Make _____
- 5 - UHF Repeater: Power _____ Make _____
- 6 - Link Ports Used as Repeater Ports: Yes No
- 7 - Serial Data Used to Control Repeater: Yes No
- 8 - Other Amateur Repeaters At the Site: Yes No
- 9 - Other Link Communication Inc. Products Used: Yes No

Misc:

- 1 - User Base: Technical Rag Chew Personal
- 2 - Autopatch used on the System: Yes No
- 3 - Frequency Adjustable Remotes: Yes No
- 4 - Linking to Other Repeaters: Yes No
- 5 - Linking Closed Access: Yes No
- 6 - PL Required on Main Repeater: Yes No Varies
- 7 - PL Required on Linking System: Yes No Varies

Please Return to:

Link Communications Inc.
P.O. Box 1071
Sidney, MT. 59270

Comments:

Chapter 1: Getting Started

Setup, Interfacing and Adjustment

This section of the manual contains everything you should need to know to get your repeater controller up and running. The numbered steps cover the basics, through connecting your radios and adjusting the RLC-Club. After that there is information concerning the other input and output features of the RLC-Club: the serial interface, the logical output and the analog input lines.

Step #1: Check the Packing List

Your package should contain the following items:

- (1) RLC-Club Repeater Controller
- (1) 2.50mm Power Connector
- (2) DB-9 Male Solder Connectors
- (1) RLC-Club Manual

If you ordered the optional Deluxe expansion board:

- (1) Deluxe Expansion board
- (1) Ribbon Cable for connection to the main controller board
- (1) DB-9 Male Solder Connector

You may also have ordered a rack cabinet or other options. If any of these parts are missing, contact Link Communications Inc.

What Each Connector is For

When you look at the back of the RLC-Club cabinet, you will see three horizontal slots. The leftmost slot provides access to the RJ-11 for the autopatch and the power jack. The middle slot is for three DB-9 connectors. The left connector is the serial port that you can connect to a computer or serial terminal to program the controller. The middle connector is for the input lines (for reading contact closures, voltages and temperatures). The rightmost connector in the middle slot is radio port #1, where you usually hook up your main repeater. It has connections for audio in, audio out, COR, PTT, and PL detect.

If you have the optional Deluxe board, there will also be three connectors showing through the rightmost slot in the cabinet. The left connector (a DB-9) is another radio port, usually used for a second repeater or a remote base. The middle connector (another DB-9) is for the output lines (used for turning things on and off). The right connector is a DB-25 and is used for interfacing with the optional DVR1.

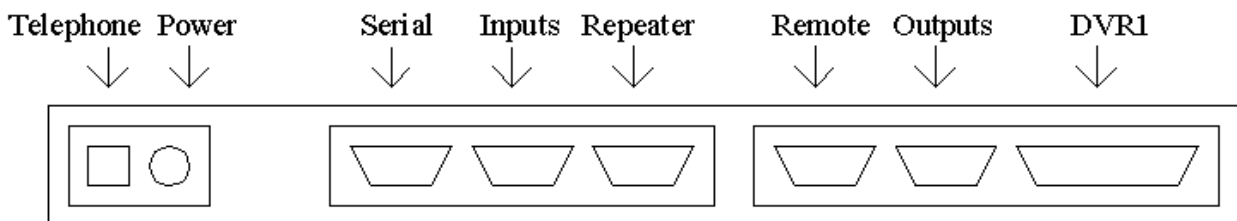

What the LED's Represent:

The RLC-Club has 12 LED's to help you get it set up and to let you how how the repeater is being used. If you purchased the rack mount cabinet, there will be labels by the LED's to help you remember what each one means. The below table lists the descriptions for the LED's and the label that is on the rack cabinet.

	Description	Front Panel Label	
1	Port 1 COR Active	C	Port 1
2	Port 1 PL Active	P	
3	Port 1 Transmitter (PTT) Active	T	
4	Port 1 DTMF Detected	D	
5	Port 2 COR Active	C	Port 2
6	Port 2 PL Active	P	
7	Port 2 Transmitter (PTT) Active	T	
8	Port 2 DTMF Detected	D	
9	Autopatch Ringing	R	Patch
10	Autopatch Off Hook	H	
11	Autopatch DTMF Detected	D	
12	DVR Active (playing or recording)	A	DVR

Step #2: Connect Power

- The RLC-Club was designed to run off of 12V DC. 11V to 14V should work fine.
- Locate the 2.50mm power connector included in your parts bag.
- Unscrew the plastic outer shield and thread your power and ground wires through it (20 gauge suggested).
- Solder the +12V wire to the center pin of the 2.50mm connector.
- Solder the ground wire to the shield of the 2.50mm power connector.
- Screw on the plastic outer shield.
- When power is applied to the RLC-Club controller, some of the front panel LED's will light indicating a PTT condition. **If none of the LED's light, turn off the power immediately.**

Step #3: Connecting Your Receivers to the RLC-Club

The radios connect to the RLC-Club using a male DB-9 connector (included). The pin-outs are listed below.

Pin Number	Description
1	Ground
2	PL Input (From your PL Decoder)
3	PTT Output (To the Transmitter)
4	Audio Output (To the Transmitter) 600 Ω
5	Audio Input (From the Receiver) 10K Ω
6	Ground
7	COR (From your Receiver)
8	Ground
9	Ground

Connecting the Receiver COR

The first step in connecting your receiver is to locate an active receiver signal. If the voltage goes from a voltage above 5 volts to ground when a signal is present, the signal is active low. If the voltage goes from a ground to a voltage above 5 volts the signal is active high. The signal must be able to sink 4mA to ground. The input impedance of the RLC-Club COR input is 10K Ω and it is diode clamped with internal pull-up resistors. This allows it to handle input voltages of up to 40 volts without damage to the controller. **The COR input must not go below 0V (ground); this would damage radio port's COR/PL input.** Using one of the supplied DB-9 Male connectors, connect your COR signal to pin #7. The COR defaults to active low. If the signal is not active low the user must change the controller's COR polarity (see command 013). The front panel LED labeled RX will light when a correct activity signal is received. If the LED lights at the wrong times, you probably have your COR or PL polarity backwards. If the LED does not light at all, the RLC-Club is not detecting your COR/PL input correctly. Use a volt meter to make sure that the signal from your receiver changes from ground to above 5 volts (or vice versa) when the receiver goes active.

Connecting a PL Input (optional)

If you wish to use a PL (CTCSS) decoder on any of the receivers, its detect line can be connected to pin #2 of the appropriate connector in the same fashion as the COR input. You can select the PL polarity (see command 013). You will probably also want to use the audio filter on the PL decoder board to filter the PL signal out of the receiver's audio before it goes to the RLC-Club.

Connecting the Receiver Audio

- 2 types of audio can be used on the RLC-Club controller:

Type 1: De-emphasized audio (Speaker Audio)

Type 2: Discriminator audio (Raw Unsquelched Audio)

- If type 1 audio is used, remove configuration jumper (Labeled J3 "-6dB Filter"). This removes the de-emphasis filter from the circuit. If you are using discriminator audio, connect J3. The filter will not allow PL to pass through the controller. Contact Link Communications Inc. if you need to pass PL through the controller.

- The audio input is connected to pin #5 of the male DB-9 connector

- The audio adjustments will be described in Step #5.

- Preferred audio input level to the controller is 100mV - 500mV peak-peak audio

Summary of Jumpers Settings



- J1 - Port 1 and/or Port 2 RLC-MOT squelch module interface connector. This connector allows direct connection to the squelch module. If the module is not used, pins 2,3 must be jumpered (Default). When using the RLC-MOT module remove the jumper and simply install the module.
- J2 - Port 1 and/or Port 2 RLC-ADM digital audio delay module interface connector. This connector allows direct connection to the digital audio delay module. If the module is not used, pins 1,2 must be jumpered (Default). When using the module make sure the RLC-ADM's connector labeled RLC-3 is the one that is loaded, not the connector at the other end. When using the RLC-ADM module remove the jumper and simply install the module.
- J3 - Port 1 and/or Port 2 -6dB deemphasis switch. When this jumper is off, flat audio is required. When this jumper is across the 2 pins, pre-emphasis audio is used.

Step #4: Connecting Your Transmitters to the RLC-Club

Transmitter PTT

- The RLC-Club produces an active low PTT signal (ground when PTT is active). This output is buffered with an open collector type driver capable of sinking 150mA. There is a built in 30V zener clamping diode to protect the PTT MOSFET from the high voltage spikes that can be caused by interfacing to a PTT relay coil. Your transmitter PTT input should be connected to pin #3 of the DB-9 connector.

Transmitter Audio

- The RLC-Club provides a 600Ω output impedance to your transmitter audio input.
 - The transmitter audio is connected to pin #4 of the DB-9 connector.
 - If it is not already, the DB-9 plug can now be plugged into the radio port connector on the controller.
 - You may need to adjust the mike level pot on your transmitter to give the controller more range in its adjustments. A good rule is to set the transmit pot on the controller mid scale in its adjustment. Then set your transmitters mike level pot to obtain the correct deviation.

Step #5: Adjusting the RLC-Club Receivers

- Locate J2 (Audio delay module connection). Connect a scope probe to the center of the provided jumper. This point is your receiver audio level. Present a stable tone (1 khz tone at 3khz deviation) and adjust the pot marked 'RX' to read 1 volt peak-peak. Make sure your audio deemphasis jumper is present if Type 2 audio is used. Repeat these same adjustments for the RLC-Club Deluxe interface.

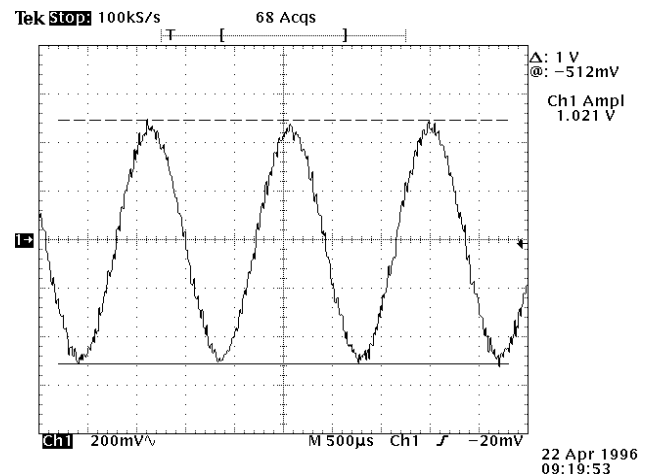

Transmitter Port Adjustment:

- Present a stable Tone or DTMF tone to the receiver that you are adjusting. Connect the receiver to the transmitters by entering "000 11" and unkeying or pressing enter, then "000 12". Once the ports are connected present a stable tone on the repeater port's receiver. Follow the adjustment described below.
 - Verify your audio is adjusted to 1 volt peak-peak as described earlier
 - Adjust the 'TX' pot on the repeater (Located on the RLC-Club board) to match your desired deviation.
 - Now move to the RLC-Club Deluxe interface if installed and adjust the 'TX' pot to match the deviation of the repeater 'TX'.
 - Your transmitters should not need any additional adjustments once 1 receiver is set up.

Step #6: Connect the Autopatch

The autopatch built into the motherboard of the RLC-Club, so all you have to do is plug a phone line into the RJ-11 phone jack on the controller. The phone line can be split if needed, with one line

going to the controller and the other to a telephone, modem, answering machine, etc.

Adjustment:

Since every phone line is different, it is easiest to just adjust the autopatch until it sounds good rather than to some specific level. Use command 110 to enable the autopatch, then enter 111 from a radio port and unkey. You should hear dial tone. If you do not, either something isn't hooked up right, or the levels are turned all the way down. Entering 114 and unkeying will hang the patch up. Once you get dial tone, try entering the phone number of someone that can help you set the levels. As soon as you press the first digit of the phone number, the dial tone should stop and after you enter the number, you should hear the phone ring. If either the dial tone continues or the phone won't ring, try adjusting the pot labeled "P.OUT". Once you are able to place a call, have the person on the other end tell you how to adjust that pot so that your voice is the right volume for them. Then have them talk and adjust the "P.IN" pot until their voice is the right volume for you.

The final adjustment is the pot labeled "DTMF". It controls the level of the DTMF digits that the controller generates to dial phone numbers. To test it, hang up the patch, then enter 113<phone number> and unkey. You will hear nothing for a few seconds while the controller dials the number, then connects the audio so you can hear the phone ring. If it doesn't ring or you hear dial tone, adjust the DTMF pot and try again until it dials consistently. If you can't get it to dial consistently, call someone using command 111 (unkey and wait for dial tone, key and enter a phone number, wait for them to answer) and use command 031 to send DTMF digits. They should be able to tell you whether the digits sound too loud or too soft.

Voice Level Adjustment:

- Generate a voice test message using RLC-CLUB command 036
Example: 036 001 002 003 004 005 006 007 D or unkey or <Enter>
- Adjust 'Voice' pot to 2 Khz deviation, this adjustment is for all transmitters. The adjustment is located next to the audio transformer and above the 'XECOM' module.

Tone Generator Adjustment:

- Generate a tone test sequence using RLC-Club Command 040:
040 2000 0001 1000 D or unkey or <Enter> will generate a 1000Hz tone for 20 seconds
- Adjust "Tone" pot on the RLC-Club to the desired deviation, 1.5Khz deviation is typical

Serial Port Interfacing

The RLC-Club has a full duplex serial port for interfacing to a computer or serial terminal; it is the connector right next to the main power plug. This connection can be made with just a cable, a telephone modem, a packet TNC, or any other method that will send the serial characters back and forth (some have even used Telnet over the Internet). You can use this serial interface to monitor and program the controller. See Appendix F for more information about controlling from the serial port.

Using a Telephone Modem

There are two ways to control the RLC-Club over the phone line. If the RLC-Club has an autopatch, you can control it using the reverse autopatch and entering commands with the telephone's DTMF pad. This works well for small changes, but if you want to do a lot of programming remotely, it is nice to do it with a computer. You can do this by putting an external modem on the controller and calling it from a modem attached to your computer (either internal or external). The modem should be connected to the controller's serial port - it has nothing to do with the autopatch. You can either run separate phone lines to the autopatch and the modem, or you can split the phone line and use it for both (one at a time, of course).



You can either have your computer call the modem and have it answer or you can have the controller call your computer. If you want to call the controller and have the modem answer and you plan to use the reverse autopatch, you will have to have a way of determining which one answers the phone. The most common way is to set the modem to answer on three rings, then to change the reverse patch setup to make it answer on either 1 or 5 rings (you can do that with a couple of macros). Whichever one answers first will make the connection. It is also possible to use a call routing interface (similar to a fax switch) to detect whether you are calling with a modem or not or to make you press DTMF digits to get to the modem.

The other option is to make the controller call your computer. This is usually done by sending a DTMF command to the controller to tell it to call you, which means you can't connect with the modem if there is a problem with your receiver. The DTMF command usually calls a macro that sends "ATDT <phone number>" to the modem (using command 162). The advantage of having the controller call you is that it doesn't conflict with the reverse patch and since the phone number is hard coded in the macro, you can be sure that no one else will call the controller with their modem and get control (since the modem can be set not to answer). If you plan to use this method, you may have to turn off line feed sending with command 060, since most modems will abort the dialing process if they receive any more serial characters after "ATDT<phone number><carriage return character>" and the controller usually sends both a carriage return and line feed at the end of each line.

Before connecting the external modem to the controller, you should connect it to your computer or serial terminal and enter some setup commands. Even if you already have a modem in your computer, you need to hook up the modem that will go on the controller to set it up. You can use a standard modem cable for this, or build one according to the chart below. Note that this cable is different than the one that you will use between the controller and the modem, even if the

connectors are the same (pins 2 and 3 are swapped).

Computer to Modem Cable

Computer DB-9	Computer DB-25	Description	Modem DB-9	Modem DB-25
3	2	Data Out of Computer	3	2
2	3	Data Into Computer	2	3
5	7	Ground	5	7

You will not need to connect the modem to the phone line to enter these setup commands. Load your communications program and set the comm port to talk to the external modem (it will probably be set for the internal modem when you start). Enter "ATZ" (without the quotes) and press enter. You will see an "OK" response if everything is hooked up right. Then enter (without the quotes, pressing enter after each command):

- "AT&F" to set everything to factory defaults.
- "ATS0=3" to make the modem answer after 3 rings or "ATS0=0" to keep the modem from answering at all.
- "AT&K0" to disable local flow control (the controller doesn't support it).
- "ATE0" to disable local echo.
- "ATQ1" to keep the modem from sending result codes.
- "AT&W" to store the settings to the modem's non-volatile memory.

If you are unable to disable your modem's flow control in software, you may have to put jumper wires between some of the pins on its DB-25 connector to fool it. Shorting pins 4 and 5 together and pins 6, 8 and 20 together should fool the flow control into working.

RS-232 Signals and Interfacing

The RLC-Club input and output is the RS-232 standard, $\pm 12V$. The pinout is standard for a 9-pin serial connector. To connect to a terminal or computer's 9-pin serial connector, use a straight-through cable (not a null modem) with at least pins 2, 3, and 5 connected. To connect to a computer with a 25-pin serial connector, you can use a standard 9 to 25-pin converter or wire your own cable. To wire your own, connect the RLC-Club's pins 2, 3, and 5 to the computer's 3, 2, and 7 respectively.

If you are connecting the controller to a modem, you will need to swap pins 2 and 3 relative to how you would connect it to a computer or run your cable through a null-modem adaptor. This is because master and slave devices (DTE and DCE devices) are wired differently. When hooking the controller and a modem (both slave devices) together, you have to adjust accordingly. The following chart summarizes the four different types of cables you may need.

Controller to Computer or Modem Cable

Controller DB-9	Description	Computer DB-9	Computer DB-25	Modem DB-9	Modem DB-25
2	Data Out of Controller	2	3	3	2
3	Data Into Controller	3	2	2	3
5	Ground	5	7	5	7

Communications Parameters

After connecting your terminal, computer, or modem (either packet or telephone) to the RLC-Club, you need to make sure that the communications parameters match on both ends. The default settings for the RLC-Club are 9600 N81:

Baud Rate	9600
Parity	None (N)
Word Length	8
Stop bits	1



You can change the baud rate the RLC-Club uses with command 024. If you are using a modem, you may be able to set the baud rate that the modem uses to communicate with the controller to be different than the speed at which it connects to the other modem. In other words, a 2400 baud modem may be able to connect to the controller at 9600 baud and to the other modem at 2400 baud.

Troubleshooting

If you can't get the connection between your computer or serial terminal and the controller to work, there are several things you can check. Make sure that the serial cable is properly connected between a serial port on your computer and the serial port on the controller and that the controller is powered up. Load your communications software (Procomm, Telix, the Windows terminal program, etc) and make sure it is set for the right comm port and baud rate. Whenever you reset the controller (or cycle the power) it will output a serial message you should see on the screen. Pressing enter should get you a "DTMF>" prompt that indicates that it is ready to accept the same commands you might enter from a radio's DTMF pad. If neither the reset message or pressing enter gets any response, double check that you have the comm port set right. Then disconnect the serial cable from the controller and short pins 2 and 3 on that end of that cable together (those are the data in and out pins). Then type on the keyboard and see if what you type shows up on the screen - it should (even with echo turned off). If you quit shorting those pins, the data should not show up on the screen. If you cannot get the data to show up on the screen by shorting those two pins, the problem is either in the computer or the cable (the controller isn't even hooked up). The most common problem is having the comm port set wrong - try all the settings. Then check your

cable again. If you still can't get it to echo, unhook the cable from the computer and try shorting pins 2 and 3 together on the serial port right at the computer, eliminating the cable as a possible problem. Again, you should see whatever you type appear on the screen. If you don't, the problem is in the computer or how you have the comm program set up. Once you get it to echo with the jumper wire at the computer, hook up the cable to the computer and try the jumper wire at the other end of the cable. If that doesn't work, the problem is in the cable. Finally hook the cable back up to the controller and try again. If the characters echo but don't work, you may be in 7 bit mode rather than 8 bit mode. If all else fails, write down how your cable is wired and call Link Communications for help. After you get it working, see Appendix F for information about controlling from the serial port.

Windows™ Programming

The RLC-Club comes with a complete Windows™ programming software program. This software runs on PC compatible computers. An 80386 or 80486 computer is recommended for running this software.

Installation:

Installation of the RLC-Club software requires a 3½" disk drive and a hard drive on your computer. Install the 3½" disk in the drive. From 'File Manager' under Windows™ select the 'A:' drive and execute the file 'Install.Exe'. The club software will auto-install itself on the hard drive under the directory '\CLUB'. An icon will now appear that allows access to the 'Club' software.

Operation:

Click on the 'Club' icon and the software will begin to run. Once the software is running you must either load an existing file or select the 'File' option and start a new file. After a file is open you can continue through the software setting up your controller.

Once your changes have been made save the file. You can either quit now or download the software to a controller via. modem software or a direct connection (with a cable connected between your computer and the controller).

Limitations:

Not all functions of the controller can be accessed from this software. We have tried to include the most often used functions in this software to ease your interfacing of the RLC-Club.

Windows™ is a registered trademark of Microsoft Corporation.

Reset and Power Up

If you have a transmitter connected to port 1, you should hear "controller ready" when you turn the power to the controller on. This message is sent whenever the controller goes through its reset routine, which happens in the following instances:

- 1) Power has just been turned on
- 2) The user has pressed the "RESET" button
- 3) The Reset command has been executed (command 035)
- 4) The controller's watchdog timer has expired. This is an internal protection timer that can reset the controller automatically if something goes wrong in the software.

When the controller resets, it does not lose any of the things you have programmed into it, like your ID's and timer settings. It does hang up the autopatch, turn off the HF remote base and a few other things, to make sure they are ready for use. It then calls a macro that makes it speak "controller ready". If you want it to speak something else or do other things when the controller resets, look into changing how the "reset macro" is programmed in Chapter 8. For information about resetting all of the variables in the controller back to factory settings, see Appendix D.

Entering Commands

It is really easy to enter commands on the controller. If you have a receiver and transmitter hooked up and adjusted, key up, press "026" on your DTMF pad, and unkey; the controller will tell you the time. Most of the commands in the controller are like this - you just have to enter the command name on your DTMF pad and unkey. If you have a computer hooked up to the serial port, you can type "026" <enter> (without the quotes) on your computer and the controller will print the time on the screen and speak it on the transmitter connected to port 1.

Entering More Digits after the Command Name:

Some of the commands take more digits; if you want to change the time, try "025 HH MM X" where HH is the hour, MM is the minute, and X is 0 if it is AM and 1 if it is PM. Command 025 needs more digits after the command name so it knows what to set the time to. The description for each command in this manual will tell you if you need to enter more digits after the command name or not.

Command Names:

When you first receive the controller (or right after everything has been set to factory settings by reinitializing - see Appendix D), all of the command names will be three digit numbers, 000 to 500. Command 26 must be entered as "026"; the leading zero is needed to make the command name three digits long. You can change any or all of the command names if you want to. You can make them almost any combination of DTMF digits up to six digits long. Normally you will want to

avoid using the digit 'D' in any of the command names. For more information about command names, see Chapter 5.

Unkey or Press 'D' to Execute:

After entering a command name and any other digits that command might require, you can tell the controller to go ahead and execute the command in several ways. If you are entering the command from a radio, you should normally just unkey. The controller will execute the command and speak a voice message to tell you what it did (except for a few commands that don't have voice messages). There may be times when the receiver's squelch is too loose and is stuck open or when someone sits on their mike when the controller won't be able to tell when you unkey. At those times, you need another way to make the commands execute. That is the purpose of the "force-execution" digit. It tells the controller to execute the command right away. It is normally set to the digit 'D'. You should not use it when it is not necessary, because as soon as you release the 'D', the controller will start speaking the command response, even if you haven't unkeyed yet, and you won't hear the first few words of that response. When you are entering commands from a computer or serial terminal, you can tell the controller to execute a command in two ways, either by entering a 'D' or pressing the enter key. When entering commands from the reverse autopatch, you can't unkey or press 'D' (on most phones), so there is another way, called "timed execution". When timed execution is turned on, you can just enter a command and wait for a few seconds and the controller will execute it. For more information about the force-execution digit and timed execution, see command 078.

Error Messages

If errors are encountered while programming the user can use this page as a reference to locate what caused the errors. Most errors are caused due to the command formats not matching what the controller is expecting. The user can change what a error macro speaks by changing the contents of the error macros. The error macros are numbered 200..219. Refer to the Macro programming section of the manual the modify and program selected macro positions.

Error 200 - Command Name Length not Matched

If the controller can not locate the command name this error is called



Error 201 - Too few data digits entered

If the controller expects more digits on a command than entered you will get this error

Error 202 - Too many data digits entered

If the controller expects less digits on a command than entered you will get this error. You can also get this error if you try to put more commands into a macro than it will hold.

Error 203 - Invalid number of data digits entered

If a command expects increments of 3 digits (Speaking a Voice Word) and you give it a wrong number of digits you will get this error.

Error 204 - Execution blocked from this port

The command you are trying to execute has been blocked from being executed.

Error 205 - User level to low to execute this command

The command you are trying to execute is at a higher user level than your assigned level. A lower level user can not execute commands assigned to a higher level.

Error 206 - This macro is reserved for internal use

Do not edit, erase or alter this macro position. It is for internal use only.

Errors 207 - Command executed OK

When a command executes correctly (User and/or macro execution) this macro is called.

Error 208 - Internal error just occurred

If you get this error please contact Link Communications, Inc. with a detailed description on how you made this error occur.

Error 209 - Macro depth limit reached

This error occurs if a macro is calling itself or you have a macro call another macro for six levels. For example, Macro 300 calls macro 301 calls macro 302 etc. for 6 levels.

Error 210 - Invalid data value entered

This error occurs if a value is entered into a command that is invalid.

Error 211 - Command does not exist

This error is similar to error macro 200 except it occurs when a listed command that is not enabled, is called. The command name exists but the command does not exist.

Error 212 - Bad Autopatch Number

You tried to enter a number in the autopatch that is invalid or blocked.

Error 213 - General Autopatch error

There is a general autopatch error that just occurred. Refer to the command you are executing and verify the format or the autopatch is not configured (See Command 110)

Error 214 - User requested is disabled

This error is encountered if a user that is disabled tries to log-on to the system. A nice voice message indicating the user is not enabled is a good used for this macro.

Error 215 - Digital Voice Recorder (DVR) is busy

This error is spoke if the DVR is currently busy and the requested DVR function can not be processed.

Error 216 - Macro is full

This error indicates a macro position if full. No more commands can be added to the specific macro.

Error 217 - HF Error

This error indicates that the last digits entered were not a valid HF command. It will usually occur when you are in HF mode (see command 198). You will probably want to disable this error message by deleting the contents of macro 217: "055 217" to avoid getting an error message every time you enter an HF command wrong.

Error 218 - Reserved**Error 219 - Reserved**

How to Configure a Port as a Repeater

The RLC-Club controller can support a repeater on both ports. This allows two stand alone repeaters to operate at the same time, on the same controller (with their own courtesy beeps, hang time, ID's, etc.). We will describe how to configure and setup port one as a repeater. Simply follow this example to configure port 2 as a repeater.

Configure the port's connection: - 000 1 1 D or unkey or <Enter>

This command connects port 1's receiver to port 1's transmitter. When you do this ports 1 receiver will cause a PTT on ports 1 transmitter. You could call this putting it into repeater mode.

Configure the port's Hang timer:

- 020 005 200 D or unkey or <Enter>

This command set the hang timer to $200 * 10\text{mS} = 2 \text{ seconds}$.

Configure the port's ID'er:

- 085 1 1 D or unkey or <Enter>

This command enables the ider for port 1. The ID timer defaults to 10 minutes.

Programming in your ID:

Macros 220, 222, 226, 228, 230, and 232 are set aside for your initial ID, rotating ID's and impolite ID's. See command 064 for more information about programming ID's.

Note: the ID's will automatically be sent to the right ports, so don't worry about the "message routing variable".

Configure the courtesy beep:

The courtesy beep is already configured and stored in Macro 232. When you execute Command 232 you will get a "beep" at 500 Hz for 200mS. To program your own beeps refer to Chapter 6, especially Command 040.

Configure the time-out timer:

The time-out timer defaults to 3 minutes and is programmable with Command 020. You can change the time out message by re-programming macro 259 and the time out clear message by re-programming macro 262.

Now your port is configured as a repeater port.

Example 1-1: Configuring a Port as a Repeater, Link

Repeaters and links indicate how a port is configured.

Repeater

A repeater is defined as a port that loops the ports receive audio out the ports transmitter. When the receiver becomes active, the transmitter of the same port should go active. When the receiver goes from active to inactive, a courtesy beep and hang time will be generated. It is required that the radios on a repeater port be only full duplex.

To convert a port into a repeater port the following command is used

000 X X

- Where X and X are the same number indicating what port the repeater is on

When the port is looped back the courtesy beep is on port 'X', ID's are started and routed to port 'X'. Time-out timers, if enabled, are running when port 'X's receiver is active.

Link

A link is defined as a port that does not loop the ports receive audio out the ports transmitter. When the receiver becomes active, the transmitters of all connected ports should go active except its own port. A link can be either half or full duplex. Full duplex links allow the ports transmitter to operate without effecting the receivers function. Half duplex links are similar to full duplex with the exception that the transmitters operation causes the receiver to be shut-off.

To convert a port into a link port the following command is used

002 X X

- Where X and X are the same number indicating what port the link is on

Monitoring a port

It is handy to monitor a connected ports receiver without keying the ports transmitter. Because the controllers full duplex ports, the controller can be monitoring another ports receiver while the monitoring port continues to have a conversation.

To monitor a port from another port the following command is used

001 X Y

- Where X is the port doing the monitoring of port Y, Y is the port being monitored

Example 1-2: Configuring a Port's COR/PL Polarity

In order for the controller to recognize a ports receiver:

The receivers COR signal is used to tell the controller when the receiver is active

An external decoder can be used to decode a receivers CTCSS 'PL' tone for controller access

Each one of these signals can be either high when active, or low when active.

What 'High' really means

A 'High' COR or PL signal indicates the input goes from a ground (0Volts) to either an open (High Z) or to a voltage above 4 volts. The controller has protection that safely allows 'High' voltages up to 15 volts without any damage to the controller. With a voltage meter you will read a voltage on the COR and PL inputs with nothing connected. This indicates the input is 'Pulled Up'. An input is 'pulled up' so the controller always has a voltage on the COR and PL inputs. This keeps the inputs from floating between 'High' and 'Low'

If you do not have a receiver connected to the controller, the controller will treat the COR and PL active high. It is very important to tell the controller the COR and PL inputs are active low if nothing is connected to the port.

What 'Low' really means

A 'Low' COR or PL signal indicates the input goes from an open or a voltage above 4 volts to ground (0Volts). Ground does not mean open or nothing connected to a pin. Ground means just that, ground or the same voltage and impedance as your power supply (-) terminal. The controller has protection that safely allows 'High' voltages up to 15 volts without any damage to the controller.

If you do not have a receiver connected to the controller, the controller will treat the COR and PL active high. It is very important to tell the controller the COR and PL inputs are active low if nothing is connected to the port.

Polarity Control

Once you have determined the ports COR and PL polarity you need to configure the controller to accept the correct polarities. The controller defaults to active 'Low' on both the COR and PL inputs of all ports. If your receivers are already 'Low' you do not need to change the configuration. If you polarity is active 'High', you need to execute Command 013 and tell the controller your correct polarity.

Active 'High' COR and active 'Low' PL (Or no PL at all) on Port 1 is configured as:

013 1 0 D or unkey (Refer to command 013 for more information)

This configured port 1 for active 'High' COR and active 'Low' PL

Troubleshooting the Controller

No LED's when the RLC-Club is powered up

- Check for +12 Volts at Power Connector
- Check for bad or blown fuse
- Make sure that the +12 Volts is connected correctly: Center of Plug is (+), Shield is (-)

No Audio at Test Bus

- Check for main system power
- Is there a valid COR signal present on the receiver: (Default: Active Low)

Have audio at the test bus, but not on the transmitter

- Are the output audio pots adjusted correctly
- Is the transmitter connected to the controller's audio output: Pin 4 on the DB-09
- Is the PTT connected to the controller: Pin 3 (Low on Transmit)

The Voice Synthesizer seems muffled

- Turn down the pot marked 'Voice'

When I connect my COR, the RLC-Club will not accept it

- My COR is set for active Low, does the COR go to ground when active
- My COR is set for active High, does the COR go to ground when inactive
- Can the COR sink (2mA) when active
- Does the 5V pull-up resistor conflict with your radio
 - Motorola R-100 Repeaters are susceptible to this
 - Open collector the driver on R-100 repeaters

When I connect my serial terminal, I do not get any data

- Is your terminal's baud rate set to 9600,N,8,1
- Are all the RS-232 TX and RX and ground wires connected
- The controller requires all RS-232 signals (TX/RX/Ground) be connected

Chapter 2: Port Connection Commands

This chapter deals with the commands used in connection and control of the radio ports. The areas dealt with in this chapter are:

- Radio port connections
- Receiver access control
- COR and PL polarity control
- Transmitter PTT control

"Connected Ports"

In this chapter you will often see references to ports being "connected". When two ports are connected, they hear each other (the COR from each port will activate the PTT on the other, and the audio from each will be transmitted out the other). All of the radio ports on the controller can work independently, or they can be connected together in any combination. If all of the ports are connected to each other, they whole controller works as one unit, with audio received on any of the receivers going out all of the transmitters.

You can make a port a repeater by connecting it to itself, so it hears (repeats) its own audio. When using a port for a link or remote base, it should not be connected to itself; when audio is received on a remote it should not be transmitted back out the remote. Instead, the audio from the remote should be transmitted out of a repeater, and the audio from the repeater should go out the remote. So the repeater port should be connected to itself (to make it a repeater) and the repeater port should be connected to the remote base port (so they can hear each other). The remote base port should not be connected to itself. To turn the remote off, you can disconnect it from the repeater port and they will no longer hear each other.

It is also possible to make a one-way connection, that is to have one port monitor another. If you make the repeater port monitor the remote base port, the people listening to the repeater would be able to hear the remote base, but the remote base would not transmit the audio received on the repeater. In this case we could say that the remote receiver is connected to the repeater transmitter, but that the repeater receiver is not connected to the remote transmitter.

When you make an autopatch call, the controller automatically connects the radio port that made the call to the autopatch port. It also may connect to the patch any ports that were connected to (or monitoring) the port that made the call, to avoid one-way conversations. It also connects the autopatch to itself (to keep it off hook when you unkey) even though it doesn't get it's own audio looped back (there is a special case in the code to break that audio connection).

Turning a Repeater Off

There is more than one way to turn a repeater off, each of which has advantages and disadvantages. For this example, we will assume that you have a repeater connected to port 1.

One option is to disable the repeater transmitter. This will keep the transmitter from coming up for any reason. It will not repeat audio, it will not ID, it will not send any messages that may be caused by the scheduler (like speaking the time on the hour) or any alarm messages, and if a remote is connected, it will not send the audio from that remote. The receiver will still work normally. You can still use the receiver to turn the repeater back on or enter any other commands, and if you have a remote base port connected to the repeater port, your receiver's audio will still go out the remote. The repeater transmitter can be disabled by entering "155 10".

Another option is to disable the repeater's receiver. In this case, the receiver will not cause any transmitters to key up and no audio that is received by that receiver will be transmitted out the repeater or any remotes. The repeater transmitter will continue to work normally. It will still ID (when it needs to), send scheduled and alarm messages, and if a remote is connected, it will still send the audio from that remote. You can disable port 1's receiver by entering "005 10".

You can also choose whether or not to allow commands to be entered when the receiver is disabled with command 005. Entering "005 100" will make the controller ignore any commands that are entered on that receiver. This may be useful for keeping someone from that is trying to break into your controller from getting in. It will also keep you from doing anything from that receiver - even turning it back on. If you set command 005 this way and disable the receiver, you will have to turn the receiver back on from another receiver on the controller, from the reverse patch, or from the serial port. If you enter "005 101" instead, the disabled receiver will still not cause any transmitters to key, but you will be able to enter commands on that receiver. If you enter "005 110", the repeater will continue to work but it won't accept any commands, including the command to turn it back on.

The final method for disabling a repeater is to disconnect the repeater port from itself by entering "002 11" (or from itself and any remotes that might be connected: "061 1"). This does not disable either the repeater receiver (it can still receive commands) or the transmitter (it can still send ID's and scheduled messages), but it keeps the repeater receiver from being heard on any transmitters and keeps the transmitter from sending the audio from any receivers. This is the best method for most systems.

Whichever of the methods you choose to turn your repeater off, you will probably want to program a macro to do it with a simple DTMF code and program another macro to turn it back on. An example of the final (recommended) method is show below. Entering "A1" should shut the repeater off and "A2" should turn it back on.

```
055 500 ;           delete macro 500
056 500 036 411 354 ;   speak "repeater off"
056 500 038 ;         be quiet for the rest of this macro
056 500 061 1 ;       disconnect all ports from port 1
010 500 A1 ;          name the repeater off code "A1"
```

055 501 ;	delete macro 501
056 501 036 411 358 ;	speak "repeater on"
056 501 038 ;	be quiet for the rest of this macro
056 501 000 11 ;	make port 1 a repeater again - this will not reconnect any remotes
010 501 A2 ;	name the repeater on code "A2"

000: Connect one Port to another Port

This command allows you to connect one radio port to another radio port. It is also used to put a port into "repeater mode", by connecting that port to itself. "Connecting a port" means that the audio in and keying source from each port become the audio out and PTT source for the other port. Connecting a port to itself makes the audio that comes in your repeater's receiver go out your repeater's transmitter, making it into a repeater. If you connect two different ports together, they will hear the activity from the other port.

```
<000> x y
```

Parameters:

- 000 is the default command name
- X is the first port to connect
- Y is the second port to connect

Default:

- Port 1 defaults as a repeater
- Port 2 defaults as a link
- Port 3 is the autopatch

Notes:

- If you want a one-way connection, where port A can monitor port B but port B can not hear port A, use command 001.
- This command makes the connection both ways. There is no need to enter both "000 12" and "000 21", for example; either command will make the connection.

Example 1:

Connect Port 1 to Port 2

```
000 1 2 D or unkey or <Enter>
```

Response:

Voice Response "1 Connect 2 On"

Example 2:

Want port 2 as a repeater port

```
000 2 2 D or unkey or <Enter>
```

Response:

Voice Response "2 Connect 2 On"

001: Monitor one Port from another Port

This command allows you to monitor one radio port from another radio port.

```
<001> x y
```

Parameters:

- 001 is the default command name
- X is the doing the monitoring of port Y
- Y is the port being monitored

Default:

- Port 1 defaults as a repeater
- Port 2 defaults as a link
- Port 3 is the autopatch

Note:

If you want a one-way connection, where port A can monitor port B but port B can not hear port A, use command 001.

Example:

Monitor Port 2 by Port 1

```
<001> 1 2 D or unkey or <Enter>
```

Response:

Voice response "1 MON 2"

002: Disconnect one Port from another Port

This command allows you to disconnect one radio port from another radio port.

```
<002> x y
```

Parameters:

- 002 is the default command name
- X is the first port to disconnect
- Y is the second port to disconnect

Default:

- Port 1 defaults as a repeater
- Port 2 defaults as a link
- Port 3 is the autopatch

Note:

If you want to break all of the connections to a port, check out Command 061.

Example 1:

Disconnect Port 1 from Port 2

```
<002> 1 2 D or unkey or <Enter>
```

Response:

Voice response "1 Connect 2 Off"

Example 2:

Port 2 is currently a repeater port. You want to return the port to a link

```
<002> 2 2 D or unkey or <Enter>
```

Response:

Voice response "2 Connect 2 Off"

003,004: Recall a Port's Connections

This command allows you to find out where port X's receiver or transmitter is connected.

<003> x	Interrogate a Receiver
---------	------------------------

<004> x	Interrogate a Transmitter
---------	---------------------------

Parameters:

- 003 is the default command name. This command finds what transmitters are connected to receiver 'X' is routed to.
- X is the receiver to recall the connections to

- 004 is the default command name. This command finds what receivers are routed to transmitter 'X'
- X is the transmitter to recall the connections to

Default:

- Port 1 defaults as a repeater
- Port 2 defaults as a link
- Port 3 is the autopatch

Example 1:

Port 1 is connected to ports 2 3

<003> 1 D or unkey or <Enter>

Response:

Voice Response "1 Connect 2 3"

Example 2:

Ports 1,2 are connected to port 3

<004> 3 D or unkey or <Enter>

Response:

Voice response "3 Connect 1 2"

005: Set Receiver and DTMF Decoder Conditions

This command lets you specify whether a user must have PL (CTCSS) to key up your repeater or whether it can be keyed with just carrier, among many other options. By selecting a “mode” from the table below, you can tell the controller what conditions must be met for a receiver to be considered active, that is to make it key connected transmitters. Each mode is described in detail on the following page.

This command also lets you specify the conditions the controller requires to be met for DTMF tones to be processed. Normally they are the same as the conditions for activating the receiver, but you can set them to be different. You can, for example, allow access to your repeater with just carrier, but require PL to enter any commands (enter “005p13”). Or you can require PL to access the repeater but provide a PL override command that can be entered with only carrier (enter “005p31”). The controller will mute DTMF digits (if you have that option enabled, see command 007) regardless of the conditions you have set to execute commands.

<005> p y	Set receiver’s access mode
<005> p y z	Set receiver’s and DTMF decoder’s access modes

Parameters:

- 005 is the default command name.
- ‘p’ is the port number (1..3)
- ‘y’ is the receiver’s access mode
- ‘z’ is the DTMF decoder’s access mode. If not specified, it will match the receiver’s access mode

Defaults:

- Receiver and DTMF decoders default to mode 1 on all ports.

Mode Definitions:

Mode	Definition
0	No Access
1	COR Access
2	PL Access
3	COR and PL Access
4	COR or PL Access
5	Always Active

Description of Modes:

- Mode 0: The receiver is effectively disabled; even if the carrier and/or PL is received, the controller will ignore that receiver and will not key connected transmitters.
- Mode 1: The controller will respond to the COR signal, allowing access with carrier. The PL signal is ignored.
- Mode 2: The controller will respond to the PL signal. The COR signal is totally ignored. This mode may cause very long squelch tails since PL decoders are generally slow to recognize when the PL tone goes away (see mode 3).
- Mode 3: Both COR and PL must be active at the same time for the controller to respond to the receiver. Repeaters that require PL usually use this mode because it eliminates the long squelch tails often heard when using mode 2. Typically, when someone keys a repeater with PL, the receiver's COR signal will go active first. The controller will ignore it for the moment. Perhaps 100 milliseconds later (the actual time varies) the PL decoder will recognize the subaudible tone and will activate the PL signal going to the controller. At that point the controller will see that the COR and PL are both active and will key up any connected transmitters (subject to the keyup delay filter and other factors). As long as both the COR and PL signals are active, the controller will consider that receiver to be active. When that person unkeys, the receiver's squelch circuit will recognize the loss of carrier very quickly (some squelch circuits are faster than others - ask about the RLC-MOT) and deactivate the COR signal. The controller will see the change in the COR signal and mute the audio right away, so you get a short squelch tail. The PL decoder will eventually figure out that the subaudible tone went away and deactivate the PL signal, perhaps 200 milliseconds later. The delay in sensing the loss of PL won't matter because the audio is already muted (unlike mode 2).
- Mode 4: Either COR or PL will cause the controller to respond to the receiver. This mode is useful if you want to allow access to a repeater without PL, but you have to set the squelch relatively tight to keep noise from keying the repeater. As long as your signal to the repeater is relatively strong, you can transmit without PL and you will get short squelch tails just like in mode 1. If you are too far away and can't get a strong enough signal to the repeater to open the squelch, you can transmit a PL tone. If your signal is strong enough for the PL decoder at the repeater to work, you will be able to talk on the repeater, even if you can't open the squelch (similar to mode 2). Note that for this mode to work, the receiver must not mute the audio going to the controller when the squelch is closed (you must use unsquelched audio). When using this mode, you should transmit PL to the repeater only when necessary, as whenever you use PL, you will get long squelch tails.
- Mode 5: The controller considers the receiver to be active all of the time, regardless of the COR and PL signals. This mode is useful for working with HF radios, with or without all-mode squelch. If the HF radio doesn't have squelch, or if it does but it is set too tight and the signal keeps dropping out, you can select this mode to tell the controller to treat it like it is always active while you are using it. You may want to change the access mode to mode 0 when you are not using it, to keep it from timing out.

Example:

You want to change the receiver and DTMF mode to COR and PL (mode 3) on port 2. Note that you don't need to specify the DTMF mode if it is the same as the receiver mode:

```
<005> 2 3 <unkey> or <005> 2 3 3
```

Response:

Voice Response "Two CAP CAP" (CAP is for Cor And PL)

Example:

You want to allow carrier access to a repeater on port 1, but you want to require PL to enter DTMF commands.

```
<005> 1 3 1
```

Response:

Voice Response "One CAP COR"

006: Recall Receiver and DTMF Decoder Conditions

This command allows you to recall the conditions set with command 005.

<006> p	Recall a port's access mode
---------	-----------------------------

Parameters:

- 006 is the default command name.
- 'p' is the port number (1..3)

009: Recall Entire Controller's Audio Crosspoint

This command allows you check the audio crosspoint conditions on all radio ports on the controller. This command will check the connected conditions and both show the crosspoint map on the RS-232 serial port, and will speak the conditions out the port that DTMF requested the conditions.

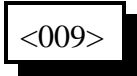

Parameters:

- 009 is the default command name.

Default:

- None

Voice Response:

The voice response will only speak if a receiver is connected on the selected port. If a receiver is connected to a port's transmitter, the controller will speak "RX connect TX" where RX and TX are the port numbers of the receiver and transmitter, respectively.

Voice Format:

- 1 Connect <TX1> <TX2> <TX3>
- 2 Connect <TX1> <TX2> <TX3>
- 3 Connect <TX1> <TX2> <TX3>

Serial Format:

		TX		
		1	2	3
RX	1	.	.	.
	2	.	.	.
	3	.	.	.

013: Set COR and PL Active Levels

This command allows you to select whether the COR and PL inputs are active low or active high. The default is active low; when the controller sees a COR line go to ground, it thinks that the receiver is getting a signal. If you have a radio or PL detector that goes high when active, you can use this command to tell the RLC-Club to consider high to be the active level.

<013> p c l	Set Active Level
<013> p 00	Reset to Defaults

Notes:

- This command does not affect the input circuits at all; it does not disable the built-in pullup resistors on the RLC-Club's COR and PL inputs.
- If you are not able to enter commands using DTMF, you may need to temporarily fool the RLC-Club into thinking that your receiver's active level is different than it is. For example, if your receiver outputs an active high COR signal to the RLC-Club, the RLC-Club will not accept DTMF commands from that receiver until its COR polarity is changed with this command. You could solve this problem by temporarily disconnecting the COR line from the receiver and manually attaching it to ground. This will cause the RLC-Club to think that the receiver is active (COR line is active low by default). You will have to disconnect that line from ground or press the 'D' key to simulate unkeying after entering each command.

Parameters:

- 013 is the default command name.
- P is the port to select the active levels for.
- C is the COR polarity, 0 for active low, 1 for active high.
- L is the PL polarity, 0 for active low, 1 for active high.

Default:

- All COR and PL inputs default to active low.

Example:

Change Port 2's COR input to active high:

```
<013> 2 1 0 D or unkey or <Enter>
```

Voice Response:

" 2 1 0"

061: Disconnect all Ports from a Radio Port

This command allows you to disconnect all of the other radio ports from one radio port with one command. Please note that if you execute this command for a repeater port, it will disconnect it from itself, breaking it out of repeater mode. To make it a repeater again, you will have to use command 000. If you only want to break some of the connections to a port, see commands 001 and 002.

```
<061> p
```

Parameters:

- 061 is the default command name
- P is the port to disconnect all other ports from

Shortcut:

If you want to break all of the connections to several ports, list all of them. For example: 061 123 D or unkey or <Enter> breaks every connection in the whole crosspoint.

Example:

Disconnect all other ports from Port 1

```
<061> 1 D or unkey or <Enter>
```

Voice Response:

"1 Clear"

155: Enable or Disable PTT for a Port

This command allows you to turn a PTT off regardless of what else the controller is doing. It doesn't matter whether it is a repeater or a link, what receivers are active, or anything else, if this command gets executed with F=0, the PTT goes off and stays off. This command is not the best way to regularly shut off a repeater or link (use Commands 000..002 for that), but will get the job done in an emergency. The only way to make the PTT work normally is to execute this command with F=1 or to reinitialize the controller.

<155> p f

Parameters:

- 155 is the default command name.
- P is which transmitter to turn off
- F is 1 to enable the PTT (the default) or 0 to disable it

Notes:

This command does not disable the receiver, so you can normally turn the repeater back on by executing this command and enabling the PTT. However, if you have the controller set up to require a challenge password and this command is password protected, you will not be able to hear the challenge with the PTT disabled so you won't be able to log on and enable the PTT again. In that case you will have to access the controller another way, such as from another radio port, from the reverse autopatch, or from the serial port.

156: Recall Which PTT are Enabled

This command allows you to recall which PTT are enabled and which have been turned off with Command 155.

<156>

Parameters:

- 156 is the default command name.

Voice Response:

Ports that are set to operate normally are listed. Any ports not listed have their PTT disabled. Normal response: "1 2 3".

Chapter 3: Audio and DTMF configurations

This chapter deals with how the controller handles DTMF digits that are received from a radio or the reverse autopatch. You can control both what is heard on the repeater while digits are being entered and what the controller does with those digits - whether it uses them to execute commands or ignores them.

Background:

The controller has a DTMF decoder that is constantly listening to each receiver. A DTMF decoder works by watching for 8 tone frequencies, 4 that represent the row and 4 that represent the column of a 16 key DTMF keypad. If a row frequency and a column frequency are detected at the same time, the decoder registers it as a valid digit and tells the microprocessor. This takes about 40 or 50 milliseconds from the time the DTMF digit starts.

DTMF Mute:

If you have the controller set to mute DTMF digits (see command 007), it will turn off the audio from that receiver to that transmitter as soon as the digit is detected. Normally you will hear the first few milliseconds of the DTMF digit before it is detected and muted, although you can avoid hearing it at all with an audio delay module (available from Link Communications).

The audio stays muted until a few seconds (see command 020, DTMF mute timers) after the digit is released. If you press another digit during those few seconds, the audio will remain off, so you won't hear any part of the second (or following) digits. So when you key up to enter a command, those listening to the repeater will hear a short beep when you hit the first digit and then your digits will be muted (unless you take too long between digits and the timer expires).

DTMF Cover Tone:

If you want to, you can turn on a "cover tone" that is sent while the DTMF digits are muted (see command 007). This beep-beep-beep over the repeater lets people know that someone is programming, so they don't just key up and talk over the silence of the DTMF mute. You can change what the cover tone sounds like by editing macro 293. You can't use a cover tone unless you have the DTMF mute turned on.

Mute and Cover Tone are set for each Transmitter:

Both the DTMF mute and cover tone are turned on and off for each transmitter (not receiver). This means that it doesn't matter which receiver the DTMF tones are coming in on. If you have just one repeater and no remotes or links, the difference doesn't matter. If you have several connected repeaters, links or remotes, it can be a bit confusing. You almost always will want DTMF mute to be turned on for the repeater transmitter. This will mute any tones before they go out on the repeater, whether those tones are entered from the repeater or from one of the connected links, remotes, or even the autopatch. DTMF tones that are heard by the repeater receiver will be muted before they go out the repeater, *but they can still go out any connected links*

or remotes. Sometimes you want this, so you can send tones down the links to control other sites. Other times, you don't want tones to go down the links; in those cases you should turn on the DTMF mute for the link port transmitters just like you did for your repeater transmitter (with command 007).

DTMF Mute Bypass:

The DTMF mute bypass can be used for sending DTMF paging codes over a repeater that mutes DTMF digits or for passing commands out a link transmitter that normally mutes DTMF tones. If enabled, it allows you press 'D' (or whatever your force-execution digit is - see command 078) as the first digit after keying up to disable the muting function until you unkey. When the 'D' is detected, the controller will ignore any digits received from that receiver until you unkey. It will not mute those digits on any transmitter and it will not try to decode those digits and execute any commands. The 'D' itself will be muted as soon as it is detected. If you do not have an audio delay module, the first part of that 'D' will be heard and might mess up whatever you are passing tones to. If the tones are going to another controller of the same kind, turn off the DTMF bypass on the other controller so the 'D' won't cause it to ignore the digits. If the first part of the 'D' not being muted is still a problem, you will have to get an audio delay for that receiver, turn DTMF mute off and enter the digits without using a 'D' first, or use the controller's command to generate DTMF digits (command 033).

Voice Falsing

As mentioned earlier, a DTMF decoder works by watching for 8 tone frequencies, 4 that represent the row and 4 that represent the column of a 16 key DTMF keypad. If a row frequency and a column frequency are detected at the same time, the decoder registers it as a valid digit. Sometimes peoples' voices have those frequencies in them and cause the DTMF decoder to think that a digit is present when it is not. If you have the DTMF mute turned on, this will cause it to be activated and your voice will "drop out" for a couple of seconds as the controller thinks it is muting a DTMF digit. If you have the cover tone turned on, you will hear it as well. The voice falsing of the DTMF decoder is not the decoder's fault - it is just watching for those tones. There are a couple of things you can do to reduce falsing. The first thing is to check all of your audio levels. If you have the receive audio turned up too high at any point before it gets to the decoder, it may be distorted, which adds harmonics and makes falsing more likely. If your audio levels are OK and you still have falsing problems, you can change a resistor that makes the decoder require that the row and column frequencies be present longer before it considers the digit to be valid. On the RLC-Club, this resistor is R14 and on the deluxe board it is R19. Some earlier controllers used a 300K resistor which caused the DTMF digits to be detected in less than 40ms, but voice falsing was common. Later controllers including all of the RLC-Club's have used a 470K resistor, which sets the decode time to about 50ms. This is still a lot faster than most people release digits, so unless you have a very fast autodialer, it should keep up. This greatly reduces the problems with falsing. In a few cases, persistent audio distortion problems or someone's voice will cause falsing even with a 470K resistor. In those cases, the resistor can be replaced with a larger one to slow the decoder down even more. Values over 700K or so should be avoided as they may keep the decoder from working at all. You can make any remaining falsing less annoying by setting the DTMF mute timer to be relatively short (1..2 sec, or even less if you have an audio delay module).

007: Configure DTMF Mute/Cover Tone/Bypass

This command allows you to program and recall whether DTMF mute is turned on/off, whether a cover tone is used when the received DTMF is present and mute and if the user enters the force-execution digit (see command 078) as the first digit in a sequence the DTMF mute is bypassed until the user unkeys thus allowing for DTMF digits to be sent for paging applications. See the beginning of this chapter for more information.

<007> p	Recall mute, cover tone and bypass settings
<007> p m	Configure DTMF mute
<007> p m c	Configure DTMF mute and cover tone
<007> p m c u	Configure DTMF mute, cover tone and bypass

Parameters:

- 007 is the default command name.
- P is the port to set up
- M turns the DTMF mute on or off (default is off)
 - 1 - Enable DTMF mute on the selected transmitter
 - 0 - Disables DTMF mute on the selected transmitter
- C (optional) turns the cover tone on or off (default is off)
 - 1 - Enable 440 hz cover tone on the selected transmitter
 - 0 - Disable 440 hz cover tone on the selected transmitter
- U (optional) turns the DTMF mute bypass on or off (default is off)
 - 1 - Enable unmute control on the selected receiver
 - 0 - Disable unmute control on the selected receiver

Example: For port 1, want to turn on DTMF mute and cover tone and turn off the mute bypass:

```
<007> 1 1 1 0 unkey, 'D' or <Enter>
```

Voice Response "1 ON ON OFF"

Notes about the Autopatch:

When using the autopatch, if the other end is hung up before the autopatch is, you may get a "second dial tone" which allows you to make another call without hanging up. Since the controller doesn't know that the other end hung up, it doesn't know that you are placing another call and will not prevent you from making a long distance call, even if long distance numbers are normally blocked. To prevent this, you can turn on the DTMF mute for the autopatch port, although there are some drawbacks to that. If you turn on DTMF mute for the autopatch port, command 111 will no longer let you dial, you will not be able to enter digits to control answering machines, leave pages, etc., or do anything else that requires passing DTMF digits entered from the radio down the phone line. In most cases, the DTMF mute can be left off with minimal risk of

abuse.

If you do turn on the DTMF mute for the autopatch port, don't turn the cover tone on. If you do and the patch hears an echo of the digits it is dialing, it will send the cover tone along with the digits and prevent the number from being dialed correctly.



008: Check DTMF Mute/Cover Tone/Bypass Settings

This command allows you to recall what was last set with command 007. Command 007 can also be used to recall the settings. The voice response is the same as command 007.

<008> p	Recall mute controls on a selected port
---------	---

Chapter 4: Timers

This chapter deals with the controllers timers and time related issues. The areas dealt with in this chapter are:

- Programming, starting, restarting and recalling timers
- Setting and recalling the time-of-day clock

020: Program a Selected Timer

This command allows you to program the controller's timer system.

```
<020> xxx y
```

```
<020> xxx yy
```

```
<020> xxx yyy
```

Parameters:

- 020 is the default command name.
- XXX is the selected timer to be programmed
- YYYY is the value to be programmed into the timer (0 to 9999)

Message Start Delay Timer:

This timer controls how long the controller will wait before sending any tones or voice messages in two situations. The first is when you enter a command and unkey; it controls how long it will be before the response to that command will be sent. If the delay is set too short, you might miss the first word or two while your HT finishes switching from transmitting to receiving. The second situation in which this timer might delay tones or voice messages is when they need to be sent out of a transmitter that is not keyed up at the time. The transmitter will be keyed for at least the length of this timer before the tone or voice is started. If this timer is too short, the transmitter might not have time to come up to full power and the beginning of the tone or voice message might be missed. If the tone or voice message is being sent down a link system with multiple hops, more time might be needed so all of the link transmitters will have time to come up.

- This timer is programmed in 10mS increments from 0..9999.
- If a timer value of 000 is entered, the timer is disabled.

Timer Number	Definition	Defaults
000	Message Start Delay Timer, Transmitter 1	500mS (050)
001	Message Start Delay Timer, Transmitter 2	"
002	Message Start Delay Timer, Autopatch	"

Courtesy Beep Delay Timer:

This timer specifies the minimum time between when a receiver unkeys and when its courtesy beep will be sent out connected repeater ports. The courtesy beep can also be delayed by other tones in the tone queues and the synthesized voice.

- This timer is programmed in 10mS increments from 001-9999
- If a timer value of 000 is entered, the transmitter will hang on the air forever.



Timer Number	Definition	Defaults
003	Courtesy Beep Delay Timer, Receiver 1	1sec (100)
004	Courtesy Beep Delay Timer, Receiver 2	"

Transmitter Hang Timer:

This timer holds the transmitter PTT active after a connected receiver goes inactive. If a courtesy beep is sent, this is the minimum time after the courtesy beep before the PTT drops. This timer only has an effect when a connected receiver has been active since the PTT went active; otherwise this timer is ignored and the mini-hang timer (timer 016..018) is the only thing that will cause a delay. You must set the mini-hang timer shorter than this timer or this timer won't have any effect, as the actual delay is the longer of the two timers.

- This timer is programmed in 10mS increments from 000-9999 (000 is OK).

Timer Number	Definition	Defaults
005	Hang Timer, Transmitter 1	2 sec (200)
006	Hang Timer, Transmitter 2	"
007	Hang Timer, Autopatch	"

DTMF Mute Timer:

This timer controls the amount of time the receiver entering DTMF stays muted. This timer needs to be short so the instances of "Voice Falsing" does not mute the audio too long. Voice falsing is the phenomenon that occurs when your voice sounds like a DTMF digit. If you set this timer too long and the DTMF decoder falses, you will have a long gap in your voice (for the length of this timer). The mute timer begins to run after the release of the DTMF key.

- This timer is programmed in 10mS Increments from 001-9999
- If a timer value of 000 is entered, your audio will be muted forever, so if you want it to be as short as possible, enter 001

Timer Number	Definition	Defaults
008	DTMF Mute Timer, Receiver 1	1 sec. (100)
009	DTMF Mute Timer, Receiver 2	"
010	DTMF Mute Timer, Autopatch	"

I/O Polling Timer:

This timer determines how often the controller checks to see if any of the input lines have changed from high to low or low to high or if any analog alarm conditions have changed. If you want quicker response to changes, shorten this timer. If you don't want to hear about changes that happen more often than every minute or so, lengthen it to a minute. The default is one second.

Timer Number	Definition	Defaults
011	I/O Polling Timer	1 sec (100)

Courtesy Beep After Voice or Tones Timer:

This timer keeps a courtesy beep from being sent immediately after a voice message. It sets the minimum amount of time the controller will wait after the voice and tone generators stop before a courtesy beep will be sent. The courtesy beep delay timers (timers 003..004) control how long after *unkeying* the controller will wait, but if they have already expired and the courtesy beep is just waiting for the voice to finish, this timer will have an effect. An example of this is when you kerchunk a repeater after a long period of inactivity and then wait for the initial ID then the courtesy beep.

- This timer is programmed in 10mS Increments from 001-9999

Timer Number	Description	Defaults
012	Courtesy Beep After Voice Timer, Transmitter 1	1 sec (100)
013	Courtesy Beep After Voice Timer, Transmitter 2	"

Doug Hall RBI-1 Delayed Send Timer:

Buffers inside the RBI-1 overflow if it is sent too many changes too quickly. The RLC-CLUB avoids this potential problem by collecting all of the changes that occur quickly (such as within a macro) and sends the combined result of all of them only when no changes have been made for the length of this timer. This timer also affects the RLC-ICM.

- This timer is programmed in 10mS Increments from 001-9999

Timer Number	Description	Defaults
014	Doug Hall RBI-1 Delayed Send Timer	500 ms (050)

HF Radio Scan Delay Timer:

This timer determines how quickly the HF radio will scan by controlling how long it waits before sending the next frequency step. Smaller timer values make it scan more quickly. It affects all three scan step sizes (slow, medium and fast) equally. It also has an effect on how quickly other changes are sent to the radio, although reasonable changes in that time won't be very noticeable. There is a limit to how quickly the controller can send command to the radio, so if setting this timer to a smaller value doesn't increase the scan speed past a certain point, you have probably reached that limit.

Some radios such as the Yaesu FT-767 require an acknowledgement to be sent after every command. This causes them to scan only half as fast as other radios given the same scan timer setting (since the controller has to send the frequency command and the acknowledgement for each step). When using those radios, you may wish to set the scan timer to about 1/2 the length you would for other radios.

- This timer is programmed in 10mS Increments from 001-9999

Timer Number	Description	Default
015	HF Scan Delay Timer	500mS (050)

Transmitter Mini-Hang Timer:

This timer holds the transmitter PTT active for a minimum time after any keying source (connected receiver, synthesized voice, tone, cw, DVR message, etc) goes inactive. It can be used to keep the transmitter from dropping out immediately after a message. To control the hang time after a connected receiver unkeys, you can also use the normal hang timers (005..007); the actual hang time will be the longer of the two.

- This timer is programmed in 10mS increments from 000-9999

Timer Number	Definition	Defaults
016	Mini-Hang Timer, Transmitter 1	1/2 sec (50)
017	Mini-Hang Timer, Transmitter 2	"
018	Mini-Hang TimerAutopatch	"

Keyup Delay Timer:

The keyup delay timer is used to keep short noise bursts that open the receiver's squelch from keying up the repeater. It can also keep people from kerchunking the repeater. When enabled, it makes the controller totally ignore keyups shorter than the default of 1/2 second. If the receiver is keyed for longer than 1/2 second, the first 1/2 second will be ignored, then it will respond normally, bringing up the transmitter, triggering the ID system, etc. To keep every keyup from being delayed, the keyup delay is automatically disabled while the repeater is being used. It is only re-enabled when the repeater is not used for a default of 60 seconds (see timers 75..78). If this timer is set to zero, the keyup delay is disabled.

Timer Number	Definition	Defaults
019	Keyup Delay Timer, RX 1	1/2 sec (50)
020	Keyup Delay Timer, RX 2	"

Wind Speed Timer:

This timer is used to help determine the wind speed indicated by an anemometer. The number of pulses counted during the length of this timer becomes the pseudo-analog value. For more information, see command 109.

Timer Number	Definition	Defaults
021	Wind Speed Timer	2.26 sec (226)



Impolite ID Timer:

This timer waits until either the timer expires or activity goes away before sending an ID.

- This timer is programmed in 1Sec increments from 001-9999
- If a timer value of 000 is entered, the controller will not interrupt a conversation to send an ID.

Timer Number	Description	Defaults
040	Impolite ID Timer, Transmitter 1	20 sec (020)
041	Impolite ID Timer, Transmitter 2	"

Initial ID Timer:

This timer times the amount of inactivity before an initial ID is sent.

- This timer is programmed in 1Sec increments from 001-9999
- If a timer value of 000 is entered, the controller will never send an initial ID.

Timer Number	Description	Defaults
042	Initial ID Timer, Transmitter 1	10 min (600)
043	Initial ID Timer, Transmitter 2	"

Pending ID Timer:

This timer times inner activity ID timer so a proper Pending ID can be send during activity.

- This timer is programmed in 1Sec increments from 001-9999
- If a timer value of 000 is entered, the controller will never send a rotating ID.
- This timer should normally be set shorter than the initial ID timer (one minute shorter works well). You may need to make sure that the length of this timer plus the length of the impolite ID timer is less than 10 minutes to meet requirements for ID timing.

Timer Number	Description	Defaults
044	Pending ID Timer, Transmitter 1	9 min (540)
045	Pending ID Timer, Transmitter 2	"

Timeout Timers:

This timer times the how long each receiver has been active. If the receiver is active longer than the length of this timer, it is disabled until it goes inactive, and its time out message (see Chapter 8 for list of macros) is sent out all transmitters that are connected to it. It is reset and the time out clear message is sent when a timed out receiver goes inactive.

- This timer is programmed in 1 second increments from 001-9999
- If a timer value of 000 is entered, the controller will never time-out.

Timer Number	Description	Defaults
046	Time Out Timer, Receiver 1	3 Min. (180)
047	Time Out Timer, Receiver 2	"
048	Time Out Timer, Autopatch	"

Dial Tone Timers:

These timers are used to limit how long the dial tone will run. The dial tone can also be stopped by other things, such as a DTMF character being entered on the port the dial tone is being set out of or the preaccess timer expiring (since indicating that a link has been preaccessed is what dial tone is used for most). If you want to generate dial tone that can't be stopped by any of these things, use Command 040 and generate a two tone chord with frequencies of 350 and 440 Hz.

- This timer is programmed in 1Sec increments from 001-9999
- If a timer value of 000 is entered, this timer will never stop the dial tone.

Timer Number	Description	Defaults
049	Dial Tone Timer, Transmitter 1	8 sec. (008)
050	Dial Tone Timer, Transmitter 2	"
051	Dial Tone Timer, Autopatch	"

Preaccess Timers:

These timers control how long the "window" of access is between when you enter the preaccess code and when you have to enter a DTMF digit or be locked out. It starts running again as soon as each DTMF digit is released, and will lock you out if it expires. When it expires, it throws away whatever DTMF digits have been entered so far and won't accept any more commands until the controller is accessed again. It also stops the dial tone when it expires.

- This timer is programmed in 1Sec increments from 001-9999
- If a timer value of 000 is entered, this timer will never expire.

Timer Number	Description	Defaults
052	Preaccess Timer, Port 1	8 sec. (008)
053	Preaccess Timer, Port 2	"
054	Preaccess Timer, Autopatch	"

User Timers:

These timers are not normally used by the controller. They are provided for your use. You can start them running by executing Command 022 and stop them with 023 (or they will stop automatically when they expire). Also, when one of these timers expires, the corresponding special macro (see Chapter 8) is automatically executed. This allows you to start these timers when certain things in the controller happen, and do something when the timer expires. These timers are programmed in one second increments.

Timer Number	Description	Defaults
055	User Timer 00	0 sec. (000)
056	User Timer 01	"
057	User Timer 02	"
058	User Timer 03	"
059	User Timer 04	"
060	User Timer 05	"
061	User Timer 06	"
062	User Timer 07	"
063	User Timer 08	"
064	User Timer 09	"
065	User Timer 10	"
066	User Timer 11	"
067	User Timer 12	"
068	User Timer 13	"
069	User Timer 14	"
070	User Timer 15	"

DTMF Interdigit Timers or Auto-execution timers (See Command 078):

These timers are used to get rid of stray DTMF digits after several second without entering any more digits. For example, if you key and press a DTMF digit, then start talking, this timer will throw that digit away after a default of 5 seconds. That way if, after you talk a while, you try to enter a command, the digit you entered 30 seconds ago won't mess it up. Of course if you unkeyed during that time, all of the digits would be either executed or discarded anyway. This also reduces problems caused by voice falsing the DTMF decoder, by discarding the incorrectly received digits if no more digits are received during the length of this timer. This timer starts running when the DTMF digit is released, so you can hold a DTMF digit as long as you like without it being discarded.

Timer Number	Description	Defaults
071	DTMF Interdigit Timer, Receiver 1	5 sec. (005)
072	DTMF Interdigit Timer, Receiver 2	"
073	DTMF Interdigit Timer, Autopatch	"

Reverse Patch Ring Timer:

This timer sets the maximum time between rings allowed for the reverse patch to work. If this timer expires between rings, the ring count starts over. This would keep the reverse patch from ever answering the phone.

- This timer is programmed in 1 second increments from 001-9999

Timer Number	Description	Defaults
074	Reverse Patch Ring Timer	10 sec. (010)

DVR Start Recording Timer:

This timer sets the maximum time allowed after entering a command to start recording a DVR message and when you actually key up to start the recording. If you wait longer than this timer, it will not record. This is so a command to record a DVR message can not be executed and end up recording someone that keys up an hour later. If you start the recording with a DTMF digit, this timer will not have any effect.

- This timer is programmed in 1 second increments from 001-9999

Timer Number	Description	Defaults
075	DVR Start Recording Timer	10 Sec. (010)

DVR Record Length Limit Timer:

This timer sets the maximum length of message that can be recorded using the DVR. If you try to record a longer message, it will be truncated at this length. Of course, if you unkey, press a DTMF digit or the DVR runs out of memory before this time is up, it will quit recording sooner. You can set this timer to be relatively long while setting up the DVR, then shorter to keep people from leaving very long voice mail messages for people.

- This timer is programmed in 1 second increments from 001-9999
- This timer defaults to 030

Timer Number	Description	Defaults
076	DVR Record Length Limit	30 sec. (030)

User Log-off Timer:

This timer specifies the amount of time between correctly executed command entries that a user has before the controller logs the user off the system.

Timer Number	Description	Defaults
077	Log-off timer for Port 1	60 sec. (060)
078	Log-off timer for Port 2	"
079	Log-off timer for the Autopatch	"
070	Log-off timer for the Serial Port	"

Internal DVR Record Window:

This timer specifies the amount of time you have between entering a command to record a message on the internal DVR and when you have to key up and actually begin recording the message. If you wait longer than this, the controller will clear the record command and you will have to enter it again.

Timer Number	Description	Defaults
081	Internal DVR Record Window RX 1	10 sec. (010)
082	Internal DVR Record Window RX 2	"
083	Internal DVR Record Window Autopatch	"

Beacon Timer:

This timer specifies the amount of time the controller will wait before trying to send the next beacon. See Chapter 19 for more information about the beaconing system.

Timer Number	Description	Defaults
084	Beacon Timer	1 sec. (001)

Tail Message Timers:

These timers determine the minimum time between tail messages being sent. If they are set to 000, a tail message will be sent every time the transmitter drops. Otherwise, a tail message will be sent before a transmitter drop only if it has been longer than the timer length since the last drop out message was sent. In no case will the tail message cause the transmitter to key up; they will only be sent if something else brings up the transmitter. For more information about tail messages, see the event triggers table associated with command 157.

Timer Number	Description	Defaults
085	Tail Message Timer TX 1	5 minutes (300)
086	Tail Message Timer TX 2	"
087	Tail Message Timer Autopatch	"

Re-Enable Keyup Delay Timers:

These timers determine how long a receiver must be inactive after being keyed up before the keyup delay will be re-enabled. See the description for timers 19..20 for more information.

Timer Number	Description	Defaults
088	Re-Enable Keyup Delay Timer, RX 1	60 seconds (60)
089	Re-Enable Keyup Delay Timer, RX 2	"

021: Recall a Timer Value

This command allows you to recall the value of a programmed timer.

```
<021> xxx
```

Parameters:

- 021 is the default command name.
- XXX is the selected timer to be programmed (See Command 020 for Timers)

022: Start a Timer

This command makes the specified timer start running, so that it will expire later. If the timer is already running, this command will make it start over. The controller automatically starts and stops most timers, but you can override the controller's normal way of doing things with this command. You can also use this command to make the user timers start running (timers 64..68).

```
<022> xxx
```

Parameters:

- 022 is the default command name.
- XXX is the selected timer to be programmed (See Command 020 for Timers)

023: Stop a Timer

This command allows you to stop a timer, so that it will not expire normally. The controller automatically stops most timers as needed, so the only time you should need to use this command is when you want to change the way the controller normally works. Most timers automatically stop when they expire.

```
<023> xxx
```

Parameters:

- 023 is the default command name.
- XXX is the selected timer to be programmed (See Command 020 for Timers)

025: Sets the Time of Day Clock

This command allows you to set the time of day clock on the RLC-Club.

`<025> hh mm a/p`

Parameters:

- 025 is the default command name.
- HH is the actual hours with leading zeros
- MM is the actual minutes with leading zeros
- a/p is the AM/PM selection (1=PM, 0=AM)

Example:

Want to set the time to 3:25 PM

`<025> 03 25 1 D or unkey or <Enter>`

Voice Response:

"<Hour> <Minute> <AM/PM>"

026: Recall the Time of Day Clock in Male Speech

This command allows you to read the Time of Day Clock. The readback is Male time reading. Refer to Command 025 for setting the clocks time.

`<026>`

Parameters:

- 026 is the default command name.

Voice Response:

"Male voice: <Hour> <Minute> <AM/PM>"

027: Recall the Time of Day Clock in Female Speech

This command allows you to read the Time of Day Clock. The readback is Female time reading. Refer to Command 025 for setting the clocks time.

<027>

Parameters:

- 027 is the default command name.

Voice Response:

"Female voice: <Hour> <Minute> <AM/PM>"

028: Sets the Date

This command allows you to set the date on the RLC-Club Clock.

```
<028> mm dd yy w
```

Parameters:

- 028 is the default command name.
- MM is the month with leading zeros
- DD is the day of the month with leading zeros
- YY is the last two digits of the year

W is the day of the week

Number	Day
1	Sunday
2	Monday
3	Tuesday
4	Wednesday
5	Thursday
6	Friday
7	Saturday

Example:

Want to set the date to January 2, 1996

```
<028> 01 02 96 3
```

029: Recall the Date

This command allows you to read the date stamp of the controller. The readback is Male date reading. Refer to Command 028 for setting the date.

<029>

Note: if you want to recall the date as part of a message, you may want to try the variable words (Appendix B, words 800 and above). Speaking those words with command 036 will let you format the date readback any way you like it.

Parameters:

- 029 is the default command name.

Voice Response:

"This is <Month> <Day> <Year> <Day of Week>"

Chapter 5: Command Names

This chapter deals with command names and controlling when those command names will be accepted and executed by the controller.

- Command name programming, checking and recalling
- Blocking and allowing command execution

How Command Names and Command Numbers are Used:

The RLC-Club controller has 500 commands. The first 200 are commands that do a specific task and are described in this manual. The rest of the commands are macros that automatically execute a sequence of other commands. The controller automatically uses some of the macros to send ID's, courtesy beeps, and other things. These macros that are called automatically are described in Chapter 8. The remainder of the macros can be used for anything you want, such as turning on a link and sending a message for example.

Command Names:

Any of the 500 commands can be executed by entering DTMF digits from a radio, from the reverse autopatch, or with a computer or serial terminal that is connected to the controller's RS-232 serial port. To execute the commands, you enter the command's name and unkey or press enter. To execute some of the first 200 commands, you have to enter more digits after the command name, to give the controller more information.

The command names default to 000, 001, 002..500. So to recall the time (command 026), you would just enter 026 and unkey. To set the time (command 025), you would enter "025" followed by the current time (two digits for the hour, two digits for the minute, and one digit to specify AM or PM). All of the other commands are similar.

You can change the name of any or all of the commands using command 010. The name can be changed to any combination of DTMF digits up to six digits long. Normally you should avoid using the 'D' as part of the command names to avoid conflicting with the force-execution digit. If you are doing your programming from a computer or serial terminal, you can use characters that aren't DTMF digits in your command names, but then you won't be able to execute them from a radio.

Command Numbers:

The controller keeps track of both what the command was originally named (what it is in the manual) and what you may have renamed it to (they start out the same, 000, 001...). The original name is sometimes called the command number and it never changes. The command number is used for several things. One of them is renaming commands. To rename command 009 to ABC, you would enter "010 009 ABC", where 010 is the rename command, 009 is the command number, and ABC is the new name. If you then change your mind and want it to be called CBA, you would enter "010 009 CBA". Note that you still use 009, not ABC, when renaming it to CBA. You

always rename the command number to the new name, not the old name to the new name. This eliminates any confusion if you forget a command's name or if you have more than one command with the same name.

Command numbers are also used when programming macros (see commands 053 and 056), setting DTMF execution masks (commands 130..132) and several other things. Remember that you use the command name to execute the commands; you sometimes use the command number as part of the information you enter after a command name.

When you execute a command from the serial port, you can enter the command name just as you would from a radio or the reverse patch, hitting enter instead of unkeying when you are finished. That is why the prompt you get when you press enter is "DTMF>"; you can enter digits just like they were DTMF digits. There is also a way to execute commands from the serial port using the command number. This is handy because the command number never changes. To execute a command using its number, just put an N at the beginning of the line, followed by the command number and any other digits that command might need (see command 080 for information about how this works internally). We could rename command 009 to ABC from the serial port just as we did from the radio, by entering "010 009 ABC" and pressing enter (spaces are always accepted but never required). But if the name of command 10 was changed, that would no longer work. If we enter "N010 009 ABC", it will work even if command 10 has been renamed because the N makes the controller use the command number for command 010 rather than its name. This is especially useful if you store a list of commands in a file on a computer (so you can upload the whole file to the controller and set it up all at once), as you don't have to worry about whether any of the commands you use in that file have been renamed. The N cannot be used from a radio, since there is no DTMF digit N. You wouldn't want it to be possible from a radio anyway, or it would be a major security problem.

Converting Command Name <--> Command Number:

Command Number ---> Command name is accomplished with Command C011

If you have forgotten the name of command number 009, you can find out what it is by entering "011 009" and unkeying or pressing enter, or you can just change it to the name you want it to have with 010.

Command Name ---> Command number is accomplished with Command 012

If you know that entering a command name of "ABC123" causes a command to execute but you don't know what command number it is executing, you can use command 012 to find out by entering "012 ABC123" and unkeying or pressing enter.

Advanced Command Naming Topics:

You probably don't need to read this section, but it is here just in case. If it doesn't make sense to you, just skip it.

The controller has a table which it uses to keep track of the information for each command. This information is used when the controller tries to find out what command you have entered the name for. If more than one command have the same name, it can also be used to intelligently figure out which one you wanted. Some of the entries are:

- Command name (including the length of the name).
- Data length: that is how many digits, if any, are needed after the command name.
- If the data length is not zero, whether the amount must be exact or whether more digits can be entered.
- DTMF execution mask (see command 130)
- User level required to execute (see Chapter 18)

For example, Command 009 would have a data length of zero, command 000 would have a data length of 2 which must be exact, and command 036 would have a minimum data length of 3, but could be longer. Other checking such as making sure that the data for 036 is a multiple of three digits and limiting the maximum length is done by the commands themselves. Where the checking is done is important. The checks that can be done with the information in the table can be used to help figure out which command you want to execute when the names are ambiguous, while the checks that are done within the commands themselves are too late.

When you enter a command and unkey or press enter, the controller scans the whole table of commands looking for a match. It ignores any commands that would be blocked by the DTMF execution mask or that require that you log on using a password to execute. It also ignores any that it knows have the wrong number of data digits after the command name (using the information in the table as discussed above), although there are some cases where it can't tell until the command is chosen and causes an error. From the remaining commands, it chooses the one with the longest name that matches what was entered. In case of a tie, it chooses the one with the lowest command number.

For example, if you have commands named "1", "12", "123", "1234" and "12345" and you enter "12399", assuming that all of them pass the initial execution mask and password and data length checks, the controller will select the command named "123" and will execute it with the data digits "99". That is it will find the longest match, then use the rest of the digits as data. Keep this in mind when you change command names to be less than three digits. If you change the "Retrieve Public Mail" command (177) to have the name "12", then enter "123" to get the mail from mailbox 3, you may instead execute command "123" because it also matches and has a longer name. If command 123 needs additional digits after the command name, the controller will figure out what you mean, but sometimes it just can't tell. So when you rename commands, keep in mind that any name that is the same as the beginning of another name might be ambiguous.

This ability of the controller to find the longest matching name can be used in several practical ways. For example, command 000 connects two ports together. It normally sends "X connect Y" as the voice response. If you have a repeater on port 1 and a link to another site on port 2, you might want the message to be "Link up" instead. You could make a macro named "00012" or "00021" that would connect the two ports and send that message. Then entering "00012" or "00021" would cause your custom message to be sent, while "00013" or any other command starting with "000" would access the normal command 000 and cause the normal "X connect Y"

message. Another example: your autopatch up code is '*' and your autodial slot is number 43. Pressing "*43" normally causes the response, "Autodial 43". You want to make it say "KC7HXB home" instead. To do this, make a macro called "*43" and make it speak that voice response, then make the call. '*' followed by any other number will still make it say "Autodial", but "*43" will find the macro and cause your custom message. This technique can also be used to turn off the time out timer for emergency numbers.

It is possible, although not recommended, to give several commands the same name. For example, 000, 009 and 036 could all be named "ABC" and the controller would always be able to figure out which one you wanted because of the information stored in the command table. Command 000 always takes exactly two data digits, 009 never takes any, and command 036 requires three or more. So "ABC" would select command 009, "ABC12" would select command 000 and connect ports 1 and 2, and "ABC001002003" would make command 036 speak "one two three". This feature is most often used when trying to clone the command codes used on a previous controller, using more than one command on this controller.

In summary, the controller lets you name commands just about any way you want to, even if it is confusing for you and it. It does its best to figure out what you mean, using the data length, DTMF execution masks and passwords to eliminate some possibilities, but sometimes it is impossible. If you can't get it to work the way you want it to, check the command names with commands 011 and 012, then start naming them back to their original names with 010 until the confusion goes away. The most common confusion is having one command that is named the same as the beginning of another command, so the longer one gets executed when you expected the shorter one. When all of the commands have their original names, there is no confusion because every command has its own unique three digit name, the command number.

010: Re-Program Command Names

This command allows you to re-name the command names on the controller. The names can be from 1 to 6 digits in length.

```
<010> xxx yyyyyy
```

Shortcut:

If you want to change the first few digits of a whole range of command names, check out command 062.

Notes:

You should avoid renaming command 080, or the 'N' method of entering commands from the serial port will quit working. See Appendix F for more information about using 'N'.

Parameters:

- 010 is the default command name.
- XXX is the command's number. It is the same as the last three digits of the command name as listed in the manual. Examples: the command number for this command (010) is 010. For command 123, the command number is 123. The command number is always three digits. Renaming the command does not change the command number - you still use the command number as listed in the manual.
- YYYYYY is the new command name.
 - You only enter as many digits for the command name as the length you want the new name to be. You do not need to enter any leading digits for the command name.

Acceptable entries:

XXX Y	- New command name is 1 digit in length
XXX YY	- New command name is 2 digits in length
XXX YYY	- New command name is 3 digits in length
XXX YYYY	- New command name is 4 digits in length
XXX YYYYY	- New command name is 5 digits in length
XXX YYYYYY	- New command name is 6 digits in length

Default:

- Command names begin with 000 and end with 500

Voice Response:

The voice response is XXX YYYYYY 'ED' [Extra Data]

- [Extra data] is the amount of additional data needed for that command.

Example #1:

Want to re-name command 013 to ABC12

- 1) Command Number is 013
- 2) New command name is ABC12
- 3) 010 013 ABC12 D or unkey or <Enter>
- 4) Voice response: 13 ABC12 ED 0

Example #2:

You changed you mind. Now you want command number 013 (which we just renamed to ABC12) to ABC123 instead.

- 1) Command Number is 013
- 2) New command name is ABC123
- 3) 010 013 ABC123 D or unkey or <Enter>
- 4) Voice response: 13 ABC123 ED 0

Note that the current command name does not matter at all, only the command number (the last three digits of the command name in the manual) and the new name.

062: *Change the Beginning of Command Names*

This command allows you to change the first one, two or three digits of the names of a range of commands. If you specify one digit, all of the command names in the range you specified will become four digits long. If you specify 2, they will be 5 long (and 3, 6). The last three digits of a command's name can not be changed with this command (see command 010). This is to avoid accidentally assigning the same name to multiple commands.

<062> bbb eee d	Change the first digit of the name in a range
<062> bbb eee dd	Change the first and second digits of the name in a range
<062> bbb eee ddd	Change the first, second and third digits of the name in a range
<062> bbb eee	Strip off enough leading digits to make each command name three digits or less. This will "undo" most of the changes made with the above formats.

Parameters:

- 062 is the default command name.
- BBB is the number of the first command in the range that you want to change
- EEE is the number of the last command in the range that you want to change
- D or DD or DDD are the new first digits of the command names

Notes:

- You should avoid renaming command 080, or the 'N' method of entering commands from the serial port will quit working. See Appendix F for more information about using 'N'.
- Any commands in the range that have names shorter than three digits long will have zeros added before their names to make them three digits long before this command changes the other digits. For example, 062 010 050 A changes C010 to A010, 123 to A123, A1 to A0A1, and # to A00#.

Example 1:

You want to change the names of all of the commands in the controller to start with '#' so that they can be executed from a 12-key touch tone pad:

```
<062> 000 500 # D or unkey or <Enter>
```

Example 2:

You want to make the names of commands 010 through 050 more difficult to guess by making them 6 digits long, starting with the digits 96C:

```
<062> 010 050 96C D or unkey or <Enter>
```

011: Recall Command Name

This command allows you to recall the name of a command. It also tells you whether it requires more digits to be entered after the command name, if so how many, and whether more digits than that will be accepted. You specify the command number (the name of the command in this manual) and the controller will look up its name.

<011> xxx

Parameters:

- 011 is the default command name.
- XXX is the command number ranging from 000-999

Voice Response:

- The voice response is XXX YYYYYY 'ED' (Number of Digits of Extra Data)
- "ED" signifies that the following number is the amount of additional data needed for that command.
 - If the word "Variable" is spoken, the controller will accept more than the specified number of digits. If not, exactly that many digits must be entered. See the discussion about command names and numbers at the beginning of this chapter for more information.

Parameters:

- 012 is the default command name.
- This command recalls the command number for the associated command name
- YYYYYY is the command name with default command name of 000-999

Voice Response:

The voice response is "Command Number (000-999)" is YYYYYY

012: Find Commands Named ...

This command tells the controller to find all of the commands that have the name you specify. Normally it will only find one command, but if you have several commands with the same name, it will list them all.

<012> y..y

Parameters:

- 012 is the default command name.
- Y..Y is the command name with default command name of 000-999

Voice Response: The voice response is "y..y is <cmd number>, <cmd number>..." or "y..y is not used" if there are no commands that have that name.

Blocking Execution from Certain Ports

Purpose of these commands:

The following three commands allow you to mark certain commands so that they can not be executed from certain ports. You might want to use this command to make it so your autopatch can not be accessed from the link ports. If you are using one of the ports as a control port, you could make all of the commands in the controller so they could only be executed from that control port. You could call these commands from the scheduler to disable some or all of the commands at night. This adds a lot of security to your controller.

Caution:

Because these commands can keep you from executing commands, they can lock you out of your own controller. If you have a terminal or computer hooked up to the serial port, these commands can not lock you out, so you don't have to worry about it. Also, you can always re-initialize the controller (see Appendix D), but that erases all of your programming and you have to be at the site to do it. In other words, be careful what commands you block and what ports you block their execution from. If you don't want to use these functions and you want to erase their names so that they can not be entered accidentally, enter the following commands:

```
Command 010 130 D or unkey or <Enter>  
Command 010 131 D or unkey or <Enter>  
Command 010 132 D or unkey or <Enter>
```

These commands erase the names of command numbers 130, 131 and 132 so that they can not be executed without renaming them to a valid name.

If you think you have locked yourself out, execute the following sequence of commands from every port you can get touch tones to, or from the serial port. If they are executed they will allow access to every command from every port and the reverse autopatch.

```
Command 131 1 000 500 D or unkey or <Enter>  
Command 131 2 000 500 D or unkey or <Enter>  
Command 131 3 000 500 D or unkey or <Enter>
```

130: Block Command Execution From Port

This command allows you to block execution of a command or a range of commands by a port. Before using it, please read the cautions on the previous page.

<130> p ccc	Block execution for a single command
<130> p ccc ddd	Block execution for a range of commands

Parameters:

- 130 is the default command name.
- P is the port to block access by
- CCC is the first command number to block
- DDD is the last command number in the range of commands to block

131: Allow Command Execution From Port

This command allows you to reverse the effects of Command 130 and allow the specified port to execute a command or range of commands again. This command is not dangerous - it can not lock you out of your own controller.

<131> p ccc	Allow execution for a single command
<131> p ccc ddd	Allow execution for a range of commands

Parameters:

- 131 is the default command name.
- P is the port to allow access by
- CCC is the first command number to allow
- DDD is the last command number in the range of commands to allow

132: Recall Blocked Ports

This command allows you to recall which ports are blocked from executing the specific command.

<132> ccc

Parameters:

- 132 is the default command name.
- CCC is the command number to recall

Chapter 6: CW, DTMF, Voice and DVR Messages

This chapter deals with all of the different types of messages that can be sent from the controller: CW, DTMF, synthesized voice and real voice from the digital voice recorder.

- Sending of CW Messages
 - CW speed and tone control
- DTMF regeneration
 - Regeneration parameters
- Send a Voice message
- Play, Record and Erase a Digital Voice Recorder message
- Generate one and two tone sequences
- DTMF Keypad test

The controller normally figures out which transmitters each message should go to. Responses to commands go to the port that executed the command, ID's go to the port that needs them, and courtesy beeps go to all of the repeaters that could hear the audio from the receiver that caused the ID. Almost all of these defaults can be overridden by the user, if you so desire. For more information about how the messages are routed and how you can change the default routing, see Chapter 16 and Appendix A.

030: Send a CW Message

This command allows you to send a CW message. It will be sent to the ports that are in the audio routing variable at the time this command is executed (for more info, see Appendix A). The message will be sent at the speed and frequency that has been set up for the specific port with 042 and 043.

```
<030> cc..cc
```

Parameters:

- 030 is the default command name.



CC is the CW data, two digits per character

CW	XX	.	CW	XX	.	CW	XX	.	CW	XX	.	CW	XX
0	00	.	A	10	.	K	20	.	U	30	.	SPACE	40
1	01	.	B	11	.	L	21	.	V	31	.	PAUSE	41
2	02	.	C	12	.	M	22	.	W	32	.	DVR 1	42
3	03	.	D	13	.	N	23	.	X	33	.	DVR 2	43
4	04	.	E	14	.	O	24	.	Y	34	.	DVR 3	44
5	05	.	F	15	.	P	25	.	Z	35	.		
6	06	.	G	16	.	Q	26	.	/	36	.		
7	07	.	H	17	.	R	27	.	0	37	.		
8	08	.	I	18	.	S	28	.	?	38	.		
9	09	.	J	19	.	T	29	.	AR	39	.		

Notes:

- This table is duplicated in Appendix C for ease of reference.
- Sending the “CW” character 42, 43 or 44 actually plays one of the internal DVR messages.

031: Send a DTMF Sequence

This command allows you to send DTMF tones. They will be sent to the ports that are in the audio routing variable at the time this command is executed (for more info, see Appendix A). See Command 044 to set up the length of the tones and pauses between tones.

```
<031> DD..DD
```

Parameters:

- 031 is the default command name.
- DD is the DTMF data (See Below)

Number	DTMF Digit
00	0
01	1
02	2
03	3
04	4
05	5
06	6
07	7
08	8
09	9
10	A
11	B
12	C
13	D
14	*
15	#
16	<Pause>

Example:

Want to send the DTMF data '0 0 0 1 1 D'

```
<031> 00 00 00 01 01 13 D or unkey or <Enter>
```

036: Send a Voice Message

This command allows you to send a voice message out of the radio ports on the controller. This is handy for building voice messages for macro sequences, sending voice ID's, etc. Which ports will send the message is determined by the current audio routing variable at the time the command is executed (see Appendix A).

```
<036> vvv..vvv
```

Parameters:

- 036 is the default command name.
- VVV is the Voice word to be spoken
 - See Appendix B for voice word numbers

Note: if you want the voice message to stop if someone keys up in the middle of the message (a polite voice message), see commands 063 and 064. These commands are often used for ID's.

066: Send a Voice Message Using English Words

This command allows you to send a voice message out of the radio ports on the controller, just like command 036 does. The difference is that you have to look up word numbers to use command 036, while this command lets you just type in the words in English, with underscores between the words. If you enter a word that isn't in the controller's voice library, it will spell it. Since DTMF keypads only have the letters A..D (if that), this command is only useful when working from the serial port. There is no polite version of this command (see commands 063 and 064).

```
<066> w..w
```

Parameters:

- 066 is the default command name.
- w..w are the words to be spoken, in English, with underscores between words

Example:

```
066 this_is_a_test_message
```

Sending DVR-1 Messages:

If you have the optional DVR-1 (Digital Voice Recorder), you can include DVR tracks in the messages you generate with this command. Simply put "DVRxxx" where 'xxx' is a track number wherever you want the DVR track to go in the message. For example: "066 this_is_a_test_pause_DVR123_repeater_DVR32" will make the synthesized voice speak "This is a test", then the DVR will play track 123, then the synthesized voice will speak "Repeater", and finally the DVR will play track 32.

040: Send One or Two Tone Sequence

This command causes a tone "sequence" to be sent out the ports specified by the routing variable (see Appendix A for information about the routing variable). A "sequence" is composed of one or two tones which are generated simultaneously for a specified duration and followed by a specified pause. Most courtesy beeps use only one tone at a time, although many have several tones in sequence. This type of courtesy beep would be generated by calling this command several times from a macro, sending a one-tone chord each time (see examples on the following pages). DTMF digits and dial tone are familiar two-tone combinations, and can be easily generated using this command.

Sequence	Command Type
Single Tone	<040> ttt ppp ffff
Single Tone	<040> tttt pppp ffff
Dual Tone	<040> ttt ppp ffff gggg
Dual Tone	<040> tttt pppp ffff gggg



Parameters:

- TTT or TTTT is a number representing the length of the tone in 10mS increments. If you use four digits for the length of the tone, you must also use four digits for the length of the pause. The tone length is limited to 60 seconds (6000).
- PPP or PPPP is a number representing the length of the pause to follow the tone in 10mS increments. If you use four digits for the length of the tone, you must also use four digits for the length of the pause. The pause length is limited to 60 seconds (6000).
- FFFF is the frequency of the primary tone in hertz. All four digits must be entered.
- GGGG is the frequency of the secondary tone in hertz. All four digits must be entered. It is only used when you want both tones active at the same time, like a DTMF tone. If you want a beep at one frequency then a beep at another frequency, call this command twice from a macro and only specify one frequency each time.

Note about Courtesy Beeps

The RLC-Club courtesy beeps are not simply a programmable beep. When it is time to send a courtesy beep, the RLC-Club decides which ports should receive the courtesy beep, sets the audio routing variable to those ports (see Appendix A), and calls that port's courtesy beep automatic macro (see Chapter 8). This makes it possible for you to make your courtesy beep do a lot more than just beep. If you call command 040 (send One, Two or Three Tone Chord), it will beep. If you call 040 more than once in the courtesy beep macro, it will beep more than once (examples below). If you call 036 (speak voice message), you will get a voice message for your courtesy beep. If you call 030, it will send CW. If you call 031, it will send DTMF. If you really want to, you could do several of the above.

Since most people want a sequence of beeps for their courtesy beep, we will provide some examples. Note that to get a single-beep courtesy beep, you just call 040 once from the courtesy beep macro. To get a three tone sequence, you call 040 three times within that macro. Below are some widely used courtesy beep sequences.

Examples:

All tone frequencies are in hertz. All times are in milliseconds.

Sequence Name	Tone 1	Tone 2	Length	Pause
1 - Bumble Bee	0330	0000	100mS	0mS
....	0500	0000	100mS	0mS
....	0660	0000	100mS	0mS
2 - Yellow Jacket	0330	0000	50mS	0mS
....	0500	0000	50mS	0mS
....	0660	0000	50mS	0mS
3 - Shooting Star	0800	0000	100mS	0mS
....	0800	0000	100mS	0mS
....	0540	0000	100mS	0mS
4 - Comet	0500	0000	100mS	0mS
....	0500	0000	100mS	0mS
....	0750	0000	100mS	0mS
5 - Stardust	0750	0000	120mS	0mS
....	0880	0000	80mS	0mS
....	1200	0880	80mS	0mS

6 - Duncicap	0440	0500	200mS	0mS
....	0440	0350	200mS	0mS
7 - Dial Tone	0440	0350	100mS	100mS
8 - Low-High Beep	0500	0000	100mS	0mS
....	0665	0000	100mS	0mS
9 - High-Low Beep	0665	0000	100mS	0mS
....	0500	0000	100mS	0mS
10 - Cover Tone	0440	0000	200mS	300mS
11 - Audible Ring Tone	0440	0480	400mS	400mS

Example:

I want port 1's courtesy beep to be number 5 as listed above.

- 1) Locate the courtesy beep macro for port 1 in Chapter 8.
- Slot 232 is Port 1's courtesy beep macro
- 2) Command 055 deletes the old contents of a macro
055 232 D or unkey or <Enter>
- 3) Command 056 appends a command onto the end of a macro - we will do the first tone
056 232 040 012 000 0750 D or unkey or <Enter>
012 is the duration of the beep in 10 millisecond increments
000 is the length of the pause in 10 millisecond increments
0750 is the frequency of the tone in hertz
- 4) Command 056 appends a command onto the end of a macro - the second tone
056 232 040 008 000 1200 D or unkey or <Enter>
008 is the duration of the beep in 10 millisecond increments
000 is the length of the pause in 10 millisecond increments
1200 is the frequency of the tone in hertz
- 5) Command 056 appends a command onto the end of a macro - the third beep
- It is a dual tone beep
056 232 040 008 000 1200 0880 D or unkey or <Enter>
008 is the duration of the beep in 10 millisecond increments
000 is the length of the pause in 10 millisecond increments
1200 is the frequency of one tone in hertz
0880 is the frequency of the other tone in hertz
- 6) Now when port 1's courtesy beep needs to be sent, the courtesy beep macro will call Command 040 three times to generate the three beeps.

041: Courtesy Beep Enable/Disable for a Selected Transmitter

This command allows you to turn courtesy beeps on or off for a selected transmitter. Normally courtesy beeps are sent out of repeater transmitters and not out of link transmitters, so if that is what you want, you won't have to change anything. If you want a courtesy beep out of a link transmitter or you want to turn courtesy beeps off for a repeater transmitter, then you should use this command.

If you want a particular receiver to quit generating courtesy beeps (to be sent out any transmitter), delete the courtesy beep macro for that receiver (see Chapter 8 for more details about the courtesy beep macros).

```
<041> p c
```

Parameters:

- 041 is the default command name.
- P is the selected port (1..8)

C is the Control number

Control Number	Description
0	Disables courtesy beeps for this transmitter
1	Enables courtesy beeps for this transmitter only if it is a repeater (the default)
2	Enables courtesy beeps for this transmitter, even if it is a link

042: Set CW Speed for a Selected Port

This command allows you to set up the CW systems speed in words per minute. The maximum CW speed the FCC allows for identification is 20 WPM, but the controller will handle 05..50 words per minute.

```
<042> p ss
```

Parameters:

- 042 is the default command name.
- P is the selected port (1..3)
- SS is the words per minute send value

Default:

All ports default to 20 words per minute

043: Set CW 2-Tone Frequencies for a Selected Port

This command allows you to set up the CW tone frequencies used by the CW system.

```
<043> p aaaa bbbb
```

Parameters:

- 043 is the default command name.
- P is the selected port (1..3)
- AAAA is the first tone frequency (0000..9999) Hz
- BBBB is the second tone frequency (0000..9999) Hz



Default:

- Tone 1 is set to 1064 Hz.
- Tone 2 is set to 0000 Hz.

Alternate Entries:

If a single tone CW frequency chord is wanted, only enter 1 frequency

- 043 P AAAA D or unkey or <Enter>

If a 2 tone CW frequency is chord wanted, enter 2 frequencies

- 043 P AAAA BBBB D or unkey or <Enter>

044: Set Up DTMF Regenerate Parameters

This command allows you to set up the DTMF regenerate parameters for each attached port. You may need to use this command to slow your DTMF tones down if a scanning DTMF decoder is on any of the attached systems that you want the RLC-CLUB to control.

```
<044> p aaaa bbbb
```

Parameters:

- 044 is the default command name.
- P is the selected port (1..3)
- AAAA is the length of the DTMF sequence in 10mS steps (0000..9999)
- BBBB is the pause between DTMF digits in 10mS steps (0000..9999)



Default:

Both length and pause set to 100mS lengths

051: Start Dial-Tone

This command allows you to generate a dial tone down for a given time down the port that requested this command. This command is used to give you an indication that access to the controller has been accomplished. This is not pre-access, simply dial tone generation. The dial tone is routed to the port that DTMF requested the command. This command is used in conjunction with the pre-access macros.

```
<051>
```

Parameters:

- 051 is the default command name.



Notes:

How to cancel the dial tone once it is running:

- 1) You can cancel the dial tone with a DTMF digit on the port dial tone is present.
- 2) When the dial tone timer expires (See Command 020)

063: Send a Polite Voice Message

This command is identical to 036 except that audio from receivers is given priority over the voice message. If a receiver that is connected to any transmitter that is sending the voice message keys up, the voice message will be discarded so you can hear the receiver instead. In other words, if you are keyed up, it will never talk over you. If you interrupt it, it will finish the word it is currently speaking and then throw the rest of the message away. This is commonly used for speaking scheduled messages, such as reading the time at the top of every hour. It could also be used for ID's, but if you want a CW ID to be sent when the voice ID is interrupted, use command 064 instead.

```
<063> vvv..vvv
```

Parameters:

- 063 is the default command name.
- VVV..VVV is a list of synthesized voice words to be spoken
(See Appendix B for word numbers)

Example: Speak the time only if it won't play over someone talking: "063 810". Note that word 810 is a special word that speaks the current time. To put that command into macro 500, enter: "053 500 063 801". You can then call macro 500 from a macro, the scheduler, a tail message, etc. to speak the time politely.

064: Send a Polite Voice Msg, If Interrupted Execute Cmd

This command is identical to Command 063 except that if a receiver is active and causes the voice message to be thrown away, it will cause another command to be executed. This is used to make a voice ID that gets interrupted cause a CW ID to be sent instead (see the example below).

```
<064> ccc vvv..vvv
```

Parameters:

- 064 is the default command name.
- CCC is the command number to execute if the message is interrupted
- VVV is the Voice word to be spoken
 - See Appendix B for voice word numbers

Example:

You want to program a polite voice pending ID message for port 1 that will send a CW ID if it is interrupted. Since the first pending ID for port 1 is sent by macro 222, we will program that macro to execute command 064. We will tell command 064 to either speak the voice ID, or if it is interrupted, to execute the impolite ID (command number 230) instead. We will make the voice ID say the words "I D" with are word numbers 039 and 034 (you would want to change this - see Appendix B for other word numbers):

```
053 222 064 230 039 034 unkey, D or <Enter>
```

The above string uses command 053 to program macro 222 to execute command number 064. When command 064 executes, it checks for receiver activity. If the receiver is active, it executes command 230 (the impolite ID). Otherwise it speaks the voice message "ID". See Chapter 11 for more information about programming ID's.

163: Keypad Test

This command will read back whatever digits are entered. This allows you to check your DTMF keypad and make sure that the controller is accepting all of the digits.

The '*' character will be spoken as 'S' and '#' will be 'P'.

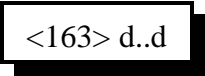

<163> d..d

Parameters:

- 163 is the default command name
- D..D are the digits to be read back

The DVR1 Digital Voice Recorder

What the DVR1 is:

The DVR1 is an optional device that allows you to record sounds, store them in memory and play them at any time. It can be used to personalize your controller by recording any message or sounds that you want and playing them back for ID messages or in place of most other synthesized voice messages. Some of these messages are played in response to commands that you or the users enter; others are played at certain times, such as for an ID. Both types of messages will be described below.

DVR Tracks:

All DVR recordings are stored in numbered "tracks." Certain tracks have special purposes and are played automatically at certain times. Others are available for you to use in any way you wish. The length of each track is limited only by available memory. Each track uses only as much storage space as is actually needed.

The first 250 tracks (numbered 000..249) have no predetermined use - you may use them for ID messages, command responses (by calling Command 173 from a macro), or anything else you can think of. Tracks 250..260 or so are used for prompting. They are discussed further in the section below titled "Recording the Prompting Tracks". The remaining tracks are not directly accessible by number. They are used to support the mailbox features and are automatically accessed by the mailbox commands.

Public Mailboxes:

The DVR uses special internal tracks to provide two types of mailboxes: public and private. Both types allow you to leave messages for other repeater users. You can leave a message in a public mailbox by simply entering the "Leave Public Mail" command (after setting up the prompting tracks as described below). The DVR will then ask you who the mail is for. You key up and say their name or call sign. The DVR will then ask you to record your message. When you are through, it will tell you that your message has been stored. You can check if there is mail for you by simply entering the "Check Public Mail" command. It will list the names or call signs of the people that there is mail for, or will tell you that there is no mail. If there is mail for you, you can listen to your message by entering the "Retrieve Public Mail" command. Up to nine public mailboxes can be in use at a time.

Private Mailboxes:

Private mailboxes allow you to leave voice mail in someone's private mailbox. To do this you have to know the number of their mailbox. There are 500 private mailboxes, so everyone in your club can have their own. Each private mailbox can hold up to five messages at a time. You can retrieve or delete the mail in your own mailbox without affecting anyone else's mailbox.

Interfacing:

The DVR1 can be ordered with or without an optional rack mount cabinet. There is not enough room to mount it inside of the RLC-CLUB cabinet. You must have the Deluxe option to use the DVR1. A DB-25 male-male cable (included) plugs into a connector on the Deluxe option board and into the DVR. The only other required connection to the DVR is power (12 volts, center positive, plug included). Optional connections include a backup power plug that can be connected to a battery pack or another power supply (make sure ground is common between the supplies) to preserve the messages stored in the DVR if the main power goes out. The remaining connector can be connected to a computer or serial terminal (more about that later). Note that this serial port is separate from the serial port on the controller.

Memory Installation and Testing:

The DVR supports four different memory configurations, all using 70ns or faster standard 30 pin simms. Either 8 or 9 bit wide simms can be used; the parity bit is ignored. You may be able to find 8 bit wide simms cheaper (they are used in Macs). Each configuration requires a different set of EPROMS in the DVR:

- Two one megabyte simms (2 megabytes total)
- Four one megabyte simms (4 megabytes total)
- Two four megabyte simms (8 megabytes total)
- Four four megabyte simms (16 megabytes total)

If only two simms are installed, they must be in the RAM #1 sockets. Note that all of the simms must be the same size. All of the memory is tested each time the DVR is powered up. If you want to see the results of the memory test, connect a computer or serial terminal to the DVR (it need not be connected to the RLC-CLUB at this time) and power up the DVR. You should see a printout on the serial screen noting how much memory is expected (based on which version of the EPROMS you have) and then how the memory test is progressing. If the DVR does not run at all, check the power and the serial connection. The DVR will attempt to run even if errors are detected during the memory test. If the memory test indicates that there are many errors, you may have the wrong size or number of simms installed, or the simms may be faulty. If there are only a few errors, you may be able to use the simms with errors in the RAM #2 sockets with only a slight loss of audio quality. Errors in the simms installed in the RAM #1 sockets are likely to cause serious problems.

The memory test performed when the DVR is powered up is very thorough and therefore can take quite a while, especially if you have a lot of memory installed, so you may have to wait for it to finish before testing. With 2, 4, 8 and 16 megabytes of memory, the test takes about 20, 40, 80 and 160 seconds (about 2.5 minutes), respectively. Since you won't be powering up very often, this shouldn't be a problem.

If you have the serial port connected and the serial screen scrolls constantly after the memory test is finished, it is probably because you don't have the DVR connected to the controller, or the controller is not powered up.

Audio Quality/Recording Time:

The audio quality of tracks played with the DVR is nearly identical to the original. You will probably not be able to distinguish between a recording and someone talking "live." Technically, the DVR samples and plays audio at 8KHz with 8 bit resolution (256 voltage levels). This uses 64000 bits per second, which is 8000 bytes per second. At this rate, each megabyte of memory will hold 131 seconds of recorded audio. A small portion of the memory is used for other purposes, so the actual amount of storage will be slightly less than 131 seconds per megabyte. In a future software version, it may be possible to record with lower quality to extend the recording time.

Adjusting the DVR:

There are only two adjustments on the DVR: record level and playback level. Both are preset before the DVRs are shipped, and should not need to be changed, at least for initial testing. When/if you do decide to adjust the levels, the playback level should be set so that the audio is played back at the same volume it was when it was "live". If you decide to change the record level, the playback level should be adjusted again before any judgement is made as to whether the new record level is better or worse. The record level is important because it affects the quality of the recording. If it is set too low, the full resolution of the digital storage will not be utilized and there will be more background noise in the audio than is necessary. If the record level is set too high, the audio peaks will be clipped off and the audio will sound distorted, especially the loudest parts.

There are many factors that determine the best level, so experiment with the Audio Check Command and adjust the record level until it sounds the best. Looking at the audio with a scope as it is played back will help identify if the record level is set too loud, as the top and bottom of the waves will be flattened (a little bit of clipping on the louder parts is normal and expected). If you have a computer or serial terminal hooked up, you can also record a message with Command 171 and look at it with the software oscilloscope function to see how much of the available range you are using.

The record and playback levels can be returned to the factory settings as follows: Set up a service monitor to generate a 1KHz tone with 3KHz deviation. Adjust the controller to get one volt peak to peak at the audio test point on the controller (the way the controller receive level is normally set up). Turn the generate function off. To make sure that the DVR is set up and working, use an HT to enter Command 170, unkey, key and say something, then unkey and listen. The DVR should play back whatever you said. If it does not, review the interfacing and testing sections above. Now key and enter Command 170 and unkey, then turn the service monitor's generate function on. This will cause the DVR to record the 1KHz tone into track 0. Adjust the voltage at pin 1 of the DVR's audio test bus for one volt peak to peak. When you get it adjusted or after 30 seconds (when the DVR will automatically quit recording), turn the generate function off and enter Command 174 0 D or unkey to erase DVR track 0. Repeat entering Command 171 0 D or unkey, recording the tone and erasing it with Command 174 0 D or unkey until you are satisfied that the record level is set, then record the 1KHz tone into DVR track 0 once more and don't erase it. Play it back by entering Command 173 0 D or unkey. While it is playing, adjust the voltage at pin 3 of the DVR's audio test bus for one volt peak to peak. Command 173 0 D or unkey may be entered as many times as needed to get the level set. This sets the DVR to play back tracks at the exact same level they were recorded at. If the transmit level is set correctly on the controller, playing this track should cause about 3KHz of deviation. Finally, erase track 0 by entering Command 174 D or unkey.

The Audio Check Command:

Before executing any DVR commands on the RLC-CLUB you should enter Command 182 1 D or unkey to tell the RLC-CLUB that the DVR is installed. The controller will respond by saying "one". If you do not do this, some of the commands will work, but others will not.

The easiest way to test the DVR is to execute the "Audio Check" command. To use it, simply key your radio and enter "Command 170", then unkey. Key up again and say something. When you unkey, the DVR will play whatever you said back to you, then erase it. If this command works, you have the DVR connected and working. You can execute this command as many times as you want to without harm and without wearing anything out. It can also be used to help you know if your signal is noisy into the repeater; just use this command to record a test message and you can listen to your own audio. Yet another use for this command is to find out how much record time (memory) is still available. To do this, start recording and count off the minutes and seconds you have been recording. When the DVR's memory is full, it will stop recording. When you unkey and the message is played back, you will hear yourself count as long as the DVR was able to record before it ran out of memory (this could take a long time if the memory is not almost full - if it takes too long, the max record length timer could stop it before the memory is full).

Recording DVR Tracks:

Before recording a track, you should make sure it is empty. If a track has already been recorded, you will not be able to record it again until you erase it. All tracks are empty when the DVR is powered up. To record a track using COR to start and stop the recording, you should enter the record command followed the track number, "171 TTT" (where TTT is the track number), then unkey (to tell the controller to execute that command and get ready to record). Then key up and start speaking your message. When you are finished, simply unkey. The DVR will automatically delete a fraction of a second of the beginning and end of your message to get rid of any noise caused by keying or unkeying.

If you wish to record a track without using COR, such as from the reverse autopatch in programming mode, you can use a DTMF digit to start and stop the recording. For example, to record track 0, you could enter "Command 171 000 D". As soon as you release the 'D', the DVR will begin recording. When you are finished speaking your message, press any DTMF digit to stop the recording. The DVR will automatically delete a fraction of a second at the end of your message to make sure that the sound of the DTMF digit is completely erased. Note that some phones (especially ones that can be used as speakerphones) mute about the first 1/2 second of each phrase you say; this makes recording nice DVR messages with them very difficult.

After you have recorded the prompting tracks (described later), you can use a more friendly version of the record command. Command 172 performs the same function as Command 171, but plays a DVR track that says something like "Please record your message now" after you enter the command and unkey (or press 'D').

When recording using either the prompted or non-prompted command, you must start recording within 10 seconds of entering the record command and unkeying or you will have to enter the command again. This is so a record command can't be entered and end up recording someone that

keys up an hour later not knowing that the record command was the last thing entered. The default 10 second window can be changed with Command 020; it is the "DVR Start Recording Timer".

The only limit on the length of message that can be recorded is the amount of memory that is still available. To keep people from leaving long mailbox messages, timer 056 can be set to limit the length of message that can be left. It defaults to 30 seconds, but can be lengthened or shortened as desired using Command 020. You may also need to lengthen your time out timer to record very long messages. Note that because some of the audio switching circuits are shared between the voice synthesizer and DVR, that only one may be playing at a time. If you play an exceptionally long DVR message, it may postpone the sending of synthesized voice ID's and other messages. For this reason, you should keep your DVR messages relatively short.



Playing Messages:

There are many things that can cause a DVR message to be played. For example, Command 170 records a message, then plays it back automatically. Command 172 plays a message to tell you to start recording a new message, then lets you record it. To simply play a message that has already been recorded, you can use Command 173. It works a lot like Command 036 does with the synthesized voice, playing the messages you request. Command 173 can be called from any macro to provide DVR ID's, courtesy beeps, autopatch off messages, etc.

Erasing Tracks:

There are several reasons to erase tracks. Tracks that have been recorded before must be erased before they can be recorded again. Tracks that are no longer being used should be erased to make more storage space available for new messages. Once a track has been erased, there is no way to recover it, so be careful when deleting tracks, especially when deleting a whole range at once. Deleting tracks can take several seconds, so don't be surprised if it takes a while before you hear the message erased message. If you are erasing a single message, the controller will continue to run normally while it waits for the DVR to finish deleting the message and send "message erased". If you delete a range of DVR messages with one command, the controller will stop everything else it is doing while it tells the DVR to delete each of the tracks. When it is finished, the DVR will speak "message erased" to let you know it is finished.

Recording the Prompting Tracks:

There are several special messages that are played automatically at certain times. They should be recorded before attempting to use the prompted record command or the mailboxes. The messages shown below are only suggestions; you can record them to say anything you want them to. To record them, enter the commands and speak the messages shown below. For more information about recording tracks, see the "Recording Tracks" section above.

Command 171 250 D or unkey	"Please record your message now"
Command 171 251 D or unkey	"Your message is stored"
Command 171 252 D or unkey (track 253 is not used)	"Message erased"
Command 171 254 D or unkey	"Who is your message for?"

Command 171 255 D or unkey "There are no messages."
 Command 171 256 D or unkey "There is mail for..."

If you want to see how your messages sound, you can play most of them by entering Command 171 250 <unkey> (for track 250). Message 256 can not be checked this way, so record it and don't worry about checking it until you try out Command 175..178. If you want to erase one of these tracks so you can record it again, enter Command 174 250 <unkey> (to erase track 250). After recording these messages, the DVR is ready for use. Flip through the manual and try all of the commands until you are comfortable with them. If you want to erase all of your messages and start over, you can erase them with Command 174 or you can unplug the DVR and controller for several seconds, then power them back up (and wait for the DVR to finish its memory test).

The Serial Interface:

The DVR includes a serial port for interfacing to a serial terminal or a computer running terminal software. This connection is not needed for normal operation, but it does provide some capabilities that are not available otherwise. Some of these are:

- The messages in the DVR can be downloaded to a computer with a hard drive for backup, including the public and private mailboxes. In the event that both the main and backup power supplies fail and the DVR's memory is erased or you have to power down to install a software upgrade, you will be able to restore all of your messages. When the messages are downloaded, it is also relatively easy to edit out dead space at the beginning and end of messages. Please note that because the DVR has such a large amount of storage and because serial port transfers are relatively slow, that downloading takes a very long time, like overnight. It can also take up to twice as much space on the hard drive as the amount of memory you have installed in the DVR.
- A "software oscilloscope" function lets you view a graphical representation of what is stored in any one of the slots. This feature is not real-time and requires that your serial terminal or terminal emulation software supports ANSI cursor control commands (most do). This feature is useful for checking how much of the range of the analog to digital converter is being used.
- A status display lets you check how much storage time is used for each message and mailbox. This can help you know what you should delete when the memory gets full.

If you have connected a terminal or computer to your RLC-CLUB, all you have to do is unplug the cable from the RLC-CLUB and plug it into the DVR. The default setting is 9600 baud, N81, the same as the default for the RLC-CLUB. If you do not already have a cable and your computer or serial terminal has a DB-9 connector, you can use a straight through DB-9 cable (not a null modem cable). If you are using a modem or TNC, note that pins 2 and 3 will have to be swapped (a null modem adapter will do this). If you are using a modem or TNC, you will probably have to set them up to make them work transparently - contact Link Communications if you need more information about how to do this.

If everything you type shows up double on your serial screen like this "tteesstt", turn the local echo off on your communications program.

The DVR is unavailable to the controller while it is executing a command entered from the serial port. Because of this, most of the serial commands will time out if you do not respond within about 10 seconds. Pressing the escape key will also get you out of most commands.

The default baud rate of 9600 baud works well for both uploading and downloading. Faster baud rates are supported, but may not work reliably. Downloading may work at a higher baud rate than uploading. When uploading, you may have to set the character pacing time (check the ASCII transfer settings on your communications program) to avoid overruns. The line pacing can be set relatively small, often to 0. When uploading at high baud rates, if the data that appears on your screen has missing or incorrect characters but you are not getting error messages, the data is probably being uploaded correctly and you can ignore the incorrect characters that you see on the screen. Most errors in uploading are caused by trying to upload to a track that is not empty. If the DVR is reset either by powering it down or by the serial reset commands, the baud rate is automatically reset to 9600 baud.

182: Enable/Disable RLC-DVR1

This command tells the RLC-CLUB if an RLC-DVR1 is installed. If you do not tell the controller that a DVR1 is installed, it will not work properly. If you tell the controller that a DVR1 is installed when it is not, it may cause problems, such as the transmitter coming up or staying up when it shouldn't. The internal DVR is always enabled; this command will not affect it at all.

<182> 0	DVR1 Not Installed (default)
<182> 1	DVR1 Is Installed



170: Record and Play Audio Test

This command makes the DVR start recording. When you unkey or press a DTMF digit to stop recording, it automatically plays it back. This is useful for testing the DVR and for checking how your signal sounds into the repeater. To use this command enter 170 and unkey, then key up and talk or enter "170 D" and start speaking immediately. When through speaking, unkey and your recording will be played back immediately. The track is automatically erased after it is played back.

<170>

Parameters:

- 170 is the default command name

171: Record DVR Track (non-prompted)

This command makes the DVR start recording a track. To use this command enter Command 171 TTT D or unkey. Either way, your message will be recorded and stored in track TTT.

<171> t	Record track 0..9
<171> tt	Record track 00..99
<171> ttt	Record track 000..260

Please note that a DVR track that has been recorded before must be erased before it can be recorded again. This is to avoid accidentally recording over an existing message.

Parameters:

- 171 is the default command name
- T, TT, TTT is the DVR track number (1..3 digits, track 0..260)

172: Record DVR Track (prompted)

This command has the same result as Command 171: it records a DVR track. The difference is that after entering the Command 172 TTT and unkeying, this command plays a special DVR track to tell you it is ready to start recording. This is useful because it lets you know that the command has been executed and the DVR is ready. After the prompting message is finished, you can key up and start recording. The disadvantage of this command compared with Command 171 is that you have to wait until the prompting message is finished before you can start recording. If you are recording a lot of tracks, it is faster to use Command 171.

<172> t	Record prompted track t
<172> tt	Record prompted track tt
<172> ttt	Record prompted track ttt

Please note that a DVR track that has been recorded before must be erased before it can be recorded again. This is to avoid accidentally recording over an existing message.

Parameters:

- 172 is the default command name
- T, TT, TTT is the DVR track number (1..3 digits, track 0..260)

173: Play DVR Tracks

This command makes the DVR start playing the specified track or tracks. They will be heard on the ports that are in the current audio routing variable (see Appendix A), just like the other commands that send tones or synthesized voice are. This is the command that you would use in an ID macro to send a DVR ID.

<173> ttt	Play single track
<173> t..t	Play multiple in-a-row tracks
<173> ttt ttt..ttt	Play multiple separate tracks

Parameters:

- 173 is the default command name
- TTT is a DVR track number. If only one track specified, can enter 1..3 digits. If more than one track is specified, must enter groups of three digits.

174: Erase DVR Tracks

This command makes the DVR erase the specified track or range of tracks. There are several reasons to erase tracks. Tracks that have been recorded before must be erased before they can be recorded again. Tracks that are no longer being used should be erased to make more storage space available for new messages. Once a track has been erased, there is no way to recover it, so use this command with caution, especially when erasing a range of tracks.

<174> ttt	Erase single track
<174> t..t	Erase multiple in-a-row tracks
<174> ttt ttt..fff	Erase multiple separate tracks

Parameters:

- 174 is the default command name
- TTT is a DVR track number to be erased. If only specify one track can use 1..3 digits.
- FFF (optional). If specified, DVR tracks TTT through FFF will be erased. FFF must be larger than TTT.

Note: If the DVR track for "message erased" is not heard, make sure you have entered Command 182 1 D or unkey to set up the DVR and that the "message erased" track has been recorded. You may have to wait for several seconds after entering the command for the DVR to finish deleting the message and send "message erased".

175: Record Public Mail

This command allows the user to record a message and who it is for and stores it in a public mailbox. It uses some of the special tracks to prompt the user to record the name or call sign and the message, and to tell him that the message has been stored. For more information, see the "Public Mailboxes" section at the beginning of the DVR section.

<175>

Parameters:

- 175 is the default command name

176: Check Public Mailboxes

This command recalls who has mail in the public mailboxes. The DVR will either play the special track that says, "There is mail for", then the name or call sign for each of the messages that are stored in the public mailboxes or it will play the special track, "There is no public mail". The names or call signs will be spoken in the order that the messages were recorded. If you want to check the public mail without the DVR saying anything if there is no mail, enter "173 256 257".

<176>

Parameters:

- 176 is the default command name

177: Retrieve Public Mail

This command allows a user that has mail in a public mailbox to retrieve it. This command is usually used after checking the public mailboxes with Command 176. When you check the public mailboxes with Command 176, you should keep track of where your name or call sign are in the list of people that have mail. For example, if Command 176 says, "There is mail for Joe, Mary, Bob, Jim", and you are Bob, your mail will be stored in public mailbox #3, because your name is third in the list. To retrieve your mail, you would enter "Command 177 3 D or unkey".

<177> s

Parameters:

- 177 is the default command name
- s is which mailbox your mail is in (1..9)

178: Erase Public Mail

This command throws away the contents of a public mailbox, the last one that was retrieved. It must be used only after retrieving a public mailbox message with Command 177. It erases only the last public mailbox message that was retrieved; all of the others remain unchanged (although they may be moved up to a lower numbered mailbox to avoid leaving gaps).

```
<178>
```

Parameters:

- 178 is the default command name

179: Record Private Mail

This command allows the user to record a message and store it in a private mailbox. You must know the mailbox number you wish to leave a message in to use this command. Since each user has his own mailbox, there is no need for you to record his name or call sign as with the public mailboxes.

```
<179> sss
```

Parameters:

- 179 is the default command name
- SSS is the number of the mailbox to leave the message in

180: Retrieve Private Mail

This command allows a user to retrieve the mail that has been left in his private mailbox. If he has no mail, the special DVR track "You have no mail" will be spoken. If there is more than one message in his mailbox, all of them will be spoken consecutively.

```
<180> sss
```

Parameters:

- 180 is the default command name
- SSS is the number of the mailbox get the mail from

181: Erase Private Mail

This command throws away the contents of a private mailbox, the last one that was retrieved. It must be used only after retrieving a private mailbox message with Command 180. It erases all of the messages in that mailbox, but does not affect any of the other private mailboxes.

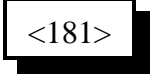

<181>

Parameters:

- 181 is the default command name

The Internal Digital Voice Recorder

The internal DVR is built into the RLC-Club controller. It gives you only some of the features and much less record time than the DVR1, but it should be enough for you to get your feet wet. It has a total of eight seconds of record time, which can be split into two four second tracks (tracks 1 and 2) or used as one combined eight second track (track 3). Be careful not to confuse the commands for the internal DVR with the commands for the DVR1.



183: Record a Message on the Internal DVR

This command allows you to record a DVR message on one of the three internal DVR message tracks. The tracks are limited to 4 seconds for tracks 1 and 2 or 8 seconds for track 3. Track 3 is simply a combination of tracks 1 and 2; don't use track 3 if you are using track 1 or track 2.



Parameters:

- 183 is the default command name.
- S is the DVR track number (1..3)

Examples:

To record track 3 from a radio, key up, enter "183 3", then unkey to execute this command and tell the controller to get ready to record. After you hear the repeater's courtesy beep, key up and speak the message you want to be recorded. Unkey when you are through speaking.

To record track 3 from the autopatch, set your force-execution digit for the autopatch port (port 3) to a '#' using command 078. Then call up on the reverse patch (which should have been set up with command 133) and enter your password. Then enter "183 3" and press the '#' digit. As soon as you release the '#', the DVR will begin recording. When you are done speaking, press the '#' again to tell the DVR to stop recording.

Notes:

- Track 1 = first 4 seconds
- Track 2 = second 4 seconds
- Track 3 = Track 1 + Track 2 = 8 seconds
- See Command 034 to adjust the record level
- When the DVR stops recording because you unkey or press a DTMF digit, it attempts to back up and erase the squelch tail or DTMF burst so that your message sounds clean. When it stops recording because it reaches the end of a track, it does not back up to avoid wasting record time.
- The audio test track defaults to using track 1, if track 1 has not been recorded. Otherwise it records on track 2. If you record a message on both tracks then do not use the test track because it will overwrite the second recorded message.

184: Playback an Internal DVR Message(s)

This command allows you to playback send one or more internal DVR messages. It will be sent to the ports that are in the audio routing variable at the time this command is executed (for more information about audio routing, see Appendix A).

<184> s	Playback a single message 1..3
<184> s..s	Playback multiple messages 1..3

Parameters:

- 184 is the default command name.
- S is the DVR track number

Notes:

- DVR messages can be intermixed with CW messages and the RLC-CLUB will make sure that they are sent in the right order. For example, you could write a macro that would send your call sign using the CW generator, then use the DVR to speak "Link Up".
- Playback of internal DVR messages is only supported on the radio ports, not on the reverse autopatch. See Command 034 for further explanation.

185: Erase Internal DVR Message(s)

This command allows you to delete one or a range of DVR messages. If an erased message is later played, it will sound like a short pause. There is no way to "un-erase" a message once it is erased.

<185> s	Erase a single message
<185> s..e	Erase multiple messages

Parameters:

- 185 is the default command name.
- S is the DVR track number to erase
- E (optional). If E is not specified, only one track will be erased. If E is specified, the DVR will delete tracks S through E.

052: Audio Test using the Internal DVR

This command allows a user to test the quality of their audio into the controller using the internal DVR system. When this command is executed the controller will record the audio and play it back. The recording is stopped when either a DTMF digit is detected or the receiver drops. Applications for this command include signal strength readback by audio quality, not just a number; testing the audio of a receiver, and checking adjustment of the DVR's record level before recording a track. This command is similar to command 170 for the optional DVR1.

<052> unkey then key up and talk

or...

<052> D then talk, unkey and listen

Parameters:

- 052 is the command name

Notes:

- The audio test track normally records on track 1. If track 1 is full it starts recording on track 2. If both tracks are empty the audio test track can be upto 8 seconds in length.
- Refer to Command 034 to adjust each port's record audio level

034: Adjust each Port's Internal DVR Record Level

This command allows the adjustment of the internal DVR's record level for each port. Because the internal DVR uses the tone generation DAC to playback the recorded voice, the level of the tones (CW and courtesy beeps) should be adjusted before adjusting record levels with this command.

<034> p	Recall Record Level for Port 'p'
<034> p lll	Set Record Level for Port 'p' to 'lll'

Parameters:

- 034 is the default command name
- P is the port to set the record level for
 - 1 - Port 1
 - 2 - Port 2
 - 3 - Reverse Autopatch (Record Only, can not play back)
- LLL is the record level adjustment number (000..255)
 - 064 is the default level

Notes:

- Ports 1,2 and the autopatch can record on the DVR but only ports 1,2 can play back
- If you adjust the record volume to high the recording will be 'raspy'
- Note: This command will not change the level of messages you have already recorded. It will change the level of messages you record afterward.

Adjustment:

- The tone level pot also adjusts the DVR voice playback level. Adjust your tones for a correct level on the port's transmitter. Once your tones are adjusted record a track with the audio test command (052) and verify the record level when the DVR track plays back. If you need to increase the record level execute Command 034 and give it a number greater than 064. If it is too loud or distorted, set the record level to a number smaller than 64. Repeat this process until you reach a level that is correct for the DVR's recording. Adjustment procedures are the same for port 2. Port 3, the autopatch, can not play back the recorded DVR message because it does not have a DAC (Digital Analog Convertor). The autopatch is allowed to record because of the increased record quality from the telephone line vs. a radio port. When recording a message from the phone the only means of verifying the recorded message is to play the message back over one of the radio ports.

Chapter 7: Serial Port Commands

This chapter deals with the the following topics:

- Information about serial transfers
- RS-232 baud rates
- Other serial port options
- Sending serial messages out of the main serial port
- Sending SPI serial data with the output lines

Where the Serial Ports Are:

The RLC-Club has a serial port on the motherboard (the closest DB-9 connector to the power jack) that is used for entering commands on the controller. This is called the main serial port. There is also a type of serial data that can be sent with the output lines that is usually used for controlling a remote base.

Controlling what Serial Messages are Sent:

This section only refers to the main serial port, since it is the one you use for entering commands and that the controller uses to tell you when there is an error. When the controller is reset (such as when the power is turned on), it sends a serial message that tells you the controller type, software version, etc. Of course you will only see this message if you have a computer or serial terminal connected to the main serial port. If you then type a command on the computer or serial terminal and press enter, the controller will process the command and print on the screen either what it did (except for a few commands that don't print anything) or an error message telling you what went wrong.

If you enter a command from a radio using DTMF, the controller normally will not print anything on the serial screen. It "suppresses" that serial so if you are programming from the serial port at the same time someone is entering DTMF commands, the responses to their commands won't confuse you. You can keep the responses to commands entered by DTMF from being suppressed by turning serial suppression off with command 060. This can be handy for figuring out what is going wrong when entering DTMF commands.

Commands 162 and 169 bypass the check to see if serial is suppressed so they always print. Since you will normally want serial suppression to be turned on, these commands are useful for sending messages that you always want to be printed, even if the command to send them is entered from a radio port or executed by the scheduler or some other internal device.

The RS-232 Serial Protocol:

Most serial devices (computers, mice, external modems, serial terminals, etc.) use the RS-232 serial protocol. The main serial port on the RLC-Club is RS-232 compatible. All you need to connect it to a computer, terminal or modem is the proper cable.

The SPI Serial Format:

There is another type of serial protocol that is totally unrelated to RS-232. It is used for controlling some remote base interfaces, such as the Doug Hall RBI-1, RLC-ICM and BCD radio interfaces. Instead of using a data in and data out line like RS-232, it uses two lines for output: data out and clock out. There is no input to the controller; data is transferred only one way. Since there is a clock line, there is no need to specify a baud rate (although there are a few timing restrictions). The RLC-Club uses the output lines on the optional Deluxe board to send this type of serial. It is sent automatically by the RBI-1 / RLC-ICM commands and can be sent manually using command 138. Remember that the outputs are open collector and require pullup resistors (pullups are built into the RBI-1 and RLC-ICM).

024: Set Up RS-232 Serial Baud Rate

This command allows you to set up the baud rate for the RLC-Club's main serial port. The baud rate for the main serial port should be set to match the computer, serial terminal, or modem that you have connected to it to program the controller with.

```
<024> x..x
```

Parameters:

- 024 is the default command name.
- x..x is the actual baud rate. Any baud rate from 300-19200 including non-standard rates can be specified. The baud rate you enter will be rounded slightly to the nearest available rate, but should always be compatible with the actual rate selected. The standard baud rates supported are 300, 600, 1200, 2400, 4800, 9600 and 19200 baud.

Default:

9600 Baud rate selected

Example:

Want to set the baud rate to 2400 baud

```
<024> 2400 unkey, 'D' or <Enter>
```

060: Set Up Serial Port Options

This command allows you to turn several options on or off for the main serial port. Each of these options is discussed below.

The first is whether or not the serial port converts all characters that you type to upper case or not. The default is to convert them, because all of the default command names are in upper case (they must be to be executed by DTMF). Converting all of the characters makes it impossible to do a few things however, such as programming serial messages that contain lower case letters.

The second allows you to choose whether the controller will send a carriage return and line feed at the end of each line (the default) or just a carriage return. The latter might be useful in situations where the line feed messes up a modem or packet radio. Most communications programs can automatically add the line feeds back in when they receive a carriage return so that the screen will scroll, rather than printing each line over top of the last one. If you are trying to make a modem dial you, you will have to turn line feed sending off or when you send "ATDT<phone number>" the controller will follow it with a CR/LF (carriage return and line feed). The CR will tell the modem to start dialing. The LF will make it stop dialing - if a modem receives any characters from the controller while it is dialing, it will abort.

The third determines whether serial messages that are generated by commands that are executed by DTMF are suppressed or printed. If they are suppressed (the default), the only serial messages that will be printed are: the reset/copyright message, serial responses to commands executed from the serial port (not DTMF), and serial messages sent with Command 162.

The fourth is whether the serial is queued (buffered) or not. Normally it is buffered so that the controller can continue to run while the serial is sent in the background. Occasionally, usually for debugging purposes, you may want the serial to be sent before execution continues. In this case, you can turn queuing off. It automatically gets turned on whenever the controller is reset.

<060> x y	Set case sensitivity and line feeds.
<060> x y z	Set case sensitivity, line feeds and suppression.
<060> x y z q	Set case sensitivity, line feeds, suppression and queuing.
<060> 0 1 1 1	Set all settings to default values.

Parameters:

- X is 1 to make the serial port case sensitive (no automatic conversion to upper case)
0 to make the serial port convert all characters entered to upper case
- Y is 1 to send line feeds (the default) or 0 to suppress them
- Z (optional) is 1 to suppress serial (the default) or 0 to send serial caused by commands entered from DTMF
- Q (optional) is 1 for queued serial (the default) or 0 to send it before continuing

032: Send Serial Message

This command allows you to send a custom message out the controller's serial port. If the message is entered with DTMF the serial message will only contain DTMF digits. If the message is entered using the RS-232 port, then the message will contain whatever characters you enter. This command is used to display serial error messages (they are sent from macros 200..219 using this command), among other things. The message will only be sent if you cause this command to be executed from the serial port or if you turn suppressed serial off with command 060, to minimize the amount of stuff being sent out of the serial port. If you want a message to be sent no matter what, use command 162.

```
<032> s..s
```

Parameters:

- 032 is the default command name.
- s..s is the data to be sent over the RS-232 port
 - The message length is limited to the maximum command length (about 200 characters) or if used in a macro, by the space left in a macro (less than 100 characters). If you need a longer message, split it up between several macros and use one macro to call the next macro in the sequence.

Voice response:

There is no voice response for this command

Notes:

- To change the baud rate, see command 024.
- Serial output is normally queued (buffered) so that controller operation does not wait for the message to be sent before continuing. Queueing can be controlled with command 060.
- Spaces are automatically stripped when the controller processes commands, including commands that send serial messages. This allows upload files to contain spaces without affecting the format of the input data. If a user wishes to have a 'space like character' sent the '_' (underscore) data can be used.

162: Always Send Serial Message out the Main Serial Port

This command is identical to Command 032 except that it always sends its message, regardless of whether command 060 is set to suppress serial sending or not.

169: Always Send Serial out Main Serial Port by ASCII Code

This command does the same thing as Command 162, but lets you enter characters by their ASCII codes. For each character you want to send, you have to enter a three digit number - that character's ASCII code (in decimal, not hex). This allows you to send characters that are not on the keyboard, or to send characters that are not on a DTMF pad when programming by DTMF. For a table of the ASCII codes, see Appendix G.

```
<169> ccc ccc ... ccc
```

Parameters:

- 169 is the default command name
- CCC is the ASCII code for one serial character.

Notes:

- To send a space with this command, use the ASCII code 032 (hex 0x20).
- This command does not automatically send carriage returns (ASCII 013) or line feeds (ASCII 010). If you do send a carriage return, the controller may automatically send a line feed afterward (see command 060).

138: Direct SPI Send using Output Lines

This command is provided only for advanced use controlling SPI devices. Unless you need to control a serial shift register or perform a direct transfer to the Doug Hall RBI-1, ignore this command. This command accepts data in hex (two digits per byte) and sends that data in an SPI format (with data and clock line) using the output lines on the Deluxe board.

<138> xx	Send individual byte
<138> xx..xx	Send multiple bytes

Parameters:

- 138 is the default command name.
- XX is the hex number (00..FF) representing a byte of data to send. To send codes with 'E' or 'F', you will have to enter this command from the serial port. You may have to change your force execution digit (see command 078) to be able to enter some hex codes. You must enter an even number of XX digits since it takes two hex digits to make one byte of data.

Notes:

- External shift registers like the 74HC164 will decode the shifted data and return it to 1's and 0's for external BCD radio control.
- Each hex digit entered corresponds with four binary digits. If you are sending only digits 0..9, they can be used as BCD data.

Key Entered	Data Sent	.	Key Entered	Data Sent
0	0000	.	8	1000
1	0001	.	9	1001
2	0010	.	A	1010
3	0011	.	B	1011
4	0100	.	C	1100
5	0101	.	D	1101
6	0110	.	E	1110
7	0111	.	F	1111

- This command is used to serially shift data using the output lines. This serial data shifted is in a format of data and clock. The format of the data is as follows:

Data Output	-	Output #7 Pin 6
Clock	-	Output #8, Pin 2
Ground	-	Pin 1

Chapter 8: Macros

How Macros Get Executed:

Macros can be executed just like any other commands: you can enter the name of the macro from a radio and unkey (or press the force execution digit), you can enter the macro name from the serial port, you enter an 'N' followed by the macro number from the serial port, etc. In addition, the controller will automatically execute macros at certain times, such as to send an ID or a courtesy beep. The macros that the controller calls in this way are called "automatic macros" because they are called automatically. The automatic macros are listed in this chapter along with descriptions of when they get executed. When the controller is reinitialized (at the factory or if you do it), many of these macros are programmed with examples of what you might want to do: the ID macros speak sample ID's, the courtesy beep macros send beeps and the I/O macros send messages that tell you what changed. You can change what is in any or all of the automatic macros to make them do what you want.

Macros numbered 400 and higher are not listed with descriptions, because the controller doesn't have a specific purpose for them; they are called "user macros". They are extras that can be used for anything else you might want to do. You will probably want to keep a list of what you use each one for so you can remember it later. After you program them, you may want to change their names and execute them from your radio with DTMF, program the automatic macros to execute them, or tell the controller to execute them at certain times using the event triggers (see Chapter 20).

What a macro is:

There are at least two common understandings of what a macro is. The RLC-Club currently supports the more flexible of the two types; eventually it may support both. The kind the RLC-Club supports could be called a "multiple command macro" because it provides a way to execute a sequence of internal commands in response to one command from the user. In other words, this kind of macro contains a list of commands that are executed in order when the macro is executed. If you commonly want to connect your repeater port to a link port and turn DTMF muting on and change your courtesy beep, you could program a macro to execute the appropriate commands. This type of macro is very similar to the macros that many word processors and other computer programs allow you to make to automate things that you do often.

The other commonly used kind of macro (that the RLC-Club does not currently support) could be called a "snapshot macro". It allows you to set up the controller the way you like it, take a snapshot of it, and restore the controller to that configuration at any time by recalling the snapshot. While this may be convenient, it is also limiting. Consider an example: you have two stand alone repeaters running off of one RLC-Club controller. You are setting up one repeater today and plan to set up the other tomorrow. You set up the repeater with a certain courtesy beep and take a snapshot. You then set it up with a different courtesy beep and take another snapshot. Now you can easily switch back and forth between the two courtesy beeps just by recalling the appropriate snapshot. The next day you set up the other repeater port in a similar way, with two different courtesy beeps. Now you start having problems. Whenever you change the courtesy beep

on one repeater, it messes up the courtesy beep on the other repeater as well, since everything gets stored in one big snapshot macro. You can't make a snapshot macro that does just what you want; it always restores a whole configuration at once.

The solution to the dilemma illustrated above is to use multiple command macros that do exactly what you want them to and nothing else. If you want a macro to connect you to Link A and not to Link B, make a multiple command macro to disconnect your repeater from Link B and connect it to Link A. Executing this macro will not interfere with anything else that is going on in the controller like a snapshot would.

Limits on Macros:

Since one macro can call another macro, you may wonder if macro 300 could call 301, which could call 302, which could call 303, etc. until you had called 100 macros or so. The answer is not quite. There are two limits. One is that if the total time it takes the processor to decode and execute the whole chained macro sequence is more than 1/2 second or so, the controller may reset itself. It is unlikely that you will ever reach this limit (it would probably take more than 20 macros all hooked together to even come close to this limit). The other limit restricts how deeply the macros can be *nested* (called from another macro). This is not a limit on how many commands can be called inside of a macro. It is not a limit on how many macros can be executed from one macro. It is a limit on one macro calling another macro that calls another macro that calls another macro. You can think of it as a limit on how deep an outline can go. For example, you execute macro 300. It calls Command 038, macro 301, and Command 000. This can be shown as the level with roman numerals:

- I Call Command 038
- II Call macro 301
- III Call Command 000 and connect port 1 and 3

Macro 301 could contain Command 007 and call macro 302. Since macro 301 is called from macro 300, it is *nested* one level deeper, to level 2. This could be shown as capital letters in the outline:

- I Call Command 038
- II Call macro 301
 - A Call Command 007
 - B Call macro 302
- III Call Command 000 and connect port 1 and 3

Macro 302 could call macros 303, 304 and 305. Macro 302 is nested one level deeper than 301, so it is at level 3.

- I Call Command 038
- II Call macro 301
 - A Call Command 007
 - B Call macro 302

- 1 Call macro 303
 - 2 Call macro 304
 - 3 Call macro 305
- III Call Command 000 and connect port 1 and 3

Macros 303, 304 and 305 are at level 4. Note that they are all at the same level. Any commands that are called from these macros will be at level 5. This is about as deep as the RLC-CLUB will let you nest macros, 5 or 6 levels. If you ever exceed this limit, error macro 209 will be executed. This is the nested macro depth limit.

200..499: Execute a Macro

These commands allow you to manually recall program macro sequences. These sequences are executed automatically by the controller to send ID's, courtesy beeps, alarm analog lines, recall input conditions, user macros, etc. You can also execute them manually by entering the command name (200 through 499). This is useful for testing the macros to make sure that they are programmed the way you want them to be.

`<200>..<499>`

Parameters:

- 200..499 is the default command name.

See Chapter 8 for automatic macro definitions.

053: Program a Single Command Macro Sequence

This command allows you to program a macro to contain one command. It does exactly the same thing as deleting the macro with Command 055, then appending it with Command 056. If you want a macro to contain more than one command, you can program the first command in the macro with this command, but you will have to use another command like Command 056 to append the rest of the commands in the macro onto the end.

```
<053> mmm ccc d..d
```

Parameters:

- 053 is the default command name.
- MMM is the macro number for this sequence to be stored in
- CCC is the command number to be executed by the macro
- D..D is the additional data associated with command MMM

Example:

Want to execute command 031 using macro 123

- 031 with 20 additional digits (1,2,3,4,5,6,7,8,9,0,9,8,7,6,5,4,3,3,2,1)

```
<053> 123 031 1234567890987654321 D or unkey or <Enter>
```

054: Recall Macro Contents

This command recalls the contents of a macro so that you can find out what the macro is programmed to do. It does not execute the commands in the macro, only recalls them to the serial screen or speaks them with the voice synthesizer. The format of the response is explained below.

```
<054> mmm
```

Parameters:

- 054 is the default command name.
- MMM is the macro number to recall

Format of the Voice Response:

"M" [macro number]
 "N" [number of commands in the macro]
 "C" [which command in the macro] [command number]
 "D" [number of digits of data] [the digits of data]
 repeat last two lines until all commands in macro have been recalled
 ? "percent" how many percent full the macro is

Example:

Recall Default Contents of Macro 200 (Command length not matched error handling macro):

You enter the command "054 200 D or unkey or <Enter>"

The serial response is:

Macro 200 contains 2 commands:
 #1 Command #032 with 31 digits of data: Command name length not matched
 #2 Command #036 with 09 digits of data: 133002028

The voice response is:

"M200" macro number 200
 "N2" number of commands in the macro is 2
 "C1 32" the first command in the macro is command number 032
 (send serial message)
 "D31" this command has 31 digits of data which are:
 "Command name length not matched" (speaks each letter, with pauses for spaces)
 "C2 36" the second command in the macro is command number 9
 "D9" this command has 9 digits of data which are:
 "133002028" the words "Error Two-Hundred"

055: Delete Macro

This command deletes a macro. If it is executed after it has been deleted, nothing will happen. There is no way to "undelete" a macro that has been deleted.

```
<055> mmm
```

Parameters:

- 055 is the default command name.
- MMM is the command number of the macro to delete.

056: Append a Command to a Macro

This command allows you to add a command to a macro. If the macro was empty (contained no commands), it becomes the first command in the macro.

```
<056> mmm ccc d..d
```

Parameters:

- 056 is the default command name.
- MMM is the macro number for this sequence to be stored in
- CCC is the command number within a macro
- D..D is the additional data associated with command CCC

Example:

Want to execute command 031 using macro 123

- Command 031 with 20 additional digits (1,2,3,4,5,6,7,8,9,0,9,8,7,6,5,4,3,3,2,1)

```
<056> 123 031 1234567890987654321 D or unkey or <Enter>
```

057: Copy a Macro

This command allows you to copy a macro. It deletes whatever used to be in the destination macro and replaces it with a copy of whatever is in the source macro.

```
<057> mmm ddd
```

Parameters:

- 057 is the default command name.
- MMM is the number of the source macro
- DDD is the number of the destination macro

058: Delete a Command in a Macro

This command allows you to delete a command in a macro without deleting the whole macro. The commands inside of the macro are numbered 00, 01, 02... so the first command is numbered 00. It may be helpful to execute command 054 to recall the contents of the macro so that you know which command to delete.

```
<058> mmm nn
```

Parameters:

- 058 is the default command name.
- MMM is the number of the macro
- NN is the number of command inside of the macro to delete (00, 01, 02...)

059: Insert a Command in a Macro

This command allows you to insert a command in a macro without deleting the following commands. This is useful for adding a command to the beginning or middle of a macro. The commands inside of the macro are numbered 00, 01, 02... so the first command is numbered 00. It may be helpful to execute command 054 to recall the contents of the macro so that you know where you want to insert the new command.

```
<059> mmm nn ccc d..d
```

Parameters:

- 059 is the default command name.
- MMM is the number of the macro
- NN is the where inside of the macro to insert the new command (00, 01, 02...)
If NN is larger than the number of commands in the macro, the new command will be appended to the macro.
- CCC is the command number of the command to insert
- D..D is the data for the above command

Automatic Macros

The following is a list of the macros that are automatically executed by the controller at certain times. Because they are executed automatically when something happens (like a timer expiring) rather than because a user specifically told it to execute by entering the macros name, they are called "automatic" macros. The only difference between automatic and user macros is who (or what) decides that they should be executed. They are named according to the function that they usually perform. If you want to change how something works, you can change what commands the macro executes to suit your own desires. An example of this would be changing an impolite ID macro to send your repeater's ID rather than the example ID that is programmed in at the factory.

You can execute any of these macros by entering its name which corresponds to its macro number followed by a 'D' or unkey or <Enter> (example 200 would execute macro 200). This is useful for finding out what is already in the macros. You find out even more about what is in a macro by recalling its contents with Command 054 D or unkey or <Enter> then the macro's number. If you do this from a serial terminal, it will be relatively easy to understand. If you do it from a DTMF pad, the voice message may seem long and complicated. This is because the synthesized voice must spell out the messages that are programmed in the macros. You can learn a lot about how the controller works by looking at what is inside of the macros with Command 054. Command 054 also tells you how many percent full a macro is. Each macro can store 100 bytes of information, about 100 keystrokes.

Automatic Macro Explanations

Macros 200..219 are where your error messages come from. Whenever an error occurs in the controller, it will cause one of these macros to be executed. To find out what caused the error, remember what the error number is and look at the description of the corresponding macro number below. You can change the error messages to say anything you want them to, or nothing at all, by changing these macros. Please note, however, that if you remove the error messages completely, that you may not be able to tell when an error occurs. See the section about error messages in Chapter 1 for more detailed descriptions.

Macro	Definition	.	Macro	Definition
200	No matching Command Name	.	210	Invalid data value
201	Too few data digits	.	211	Command does not exist
202	Too many data digits	.	212	Bad Autopatch number
203	Invalid number of data digits	.	213	Autopatch error
204	Execution blocked from port	.	214	Invalid User
205	User level to low	.	215	DVR is busy
206	Reserved	.	216	Macro is full
207	Command executed OK	.	217	HF Error
208	Internal problem	.	218	Not Defined
209	Macro depth problem	.	219	Not Defined

Macros 220..231 These macros are automatically called when it is time to send an ID. You will want to erase (with Command 055) what is in these macros when you get the controller and put your own ID messages in these macros. It would be worth your time to study the way these ID's are programmed at the factory (see Command 054) so that you can make yours work the same way. Note that Command 064 is used to speak the voice ID's so that they will be polite and will automatically call the impolite ID macro (which is usually CW) if they are interrupted. Shortcut: if you want all four of the pending ID's for a port to send the same message, program that message in the first of the four pending ID macros, then program the other three to execute the first one. To change the ID timers, see Command 020.

Macro	Definition	.	Macro	Definition
220	Port 1 Initial ID	.	226	Port 1 Pending ID #3
221	Port 2 Initial ID	.	227	Port 2 Pending ID #3
222	Port 1 Pending ID #1	.	228	Port 1 Pending ID #4
223	Port 2 Pending ID #1	.	229	Port 2 Pending ID #4
224	Port 1 Pending ID #2	.	230	Port 1 Impolite ID
225	Port 2 Pending ID #2	.	231	Port 2 Impolite ID

Macros 232..233 are executed when it is time to send a courtesy beep. You would normally call Command 040 from this macro to generate the tones of your courtesy beep. If you want your courtesy beep to contain several beeps in sequence, you can call Command 040 multiple times within one macro, once for each beep.

Note: Before this macro is automatically called after you unkey, the audio routing variable is set to make the tones go to the proper ports, so you do not have to worry about that at all. Just call the commands you want to be executed when it is time for a courtesy beep (you could send beeps, DTMF digits, voice messages...) and the audio will automatically be sent to the correct ports. To change the courtesy beep timers, see Command 020.

Macro	Definition
232	Port 1 Courtesy Beep Slot
233	Port 2 Courtesy Beep Slot

Macros 234..238 are called when Analog 1..5 go into a High alarm. You may want to use these macros to speak an voice message indicating the alarm and/or take some other action such as turning off an output line. To change how often the RLC-Club checks to see if an alarm has occurred, see Command 020. The default is every one second.

Macro	Definition
234	Analog 1, High Alarm
235	Analog 2, High Alarm
236	Analog 3, High Alarm
237	Analog 4, High Alarm
238	Analog 5, High Alarm

Macros 239..243 are called when Analog 1..5 go into a Low alarm. You may want to use these macros to indicate an alarm condition.

Macro	Definition
239	Analog 1, Low Alarm
240	Analog 2, Low Alarm
241	Analog 3, Low Alarm
242	Analog 4, Low Alarm
243	Analog 5, Low Alarm

Macros 244..248 are called when Analog 1..5 go out of either High or Low alarm into a Normal condition. You may want to use these macros to indicate that the analog reading is no longer causing an alarm.

Macro	Definition
244	Analog 1, Alarm to Normal
245	Analog 2, Alarm to Normal
246	Analog 3, Alarm to Normal
247	Analog 4, Alarm to Normal
248	Analog 5, Alarm to Normal

Macros 249..253 are called when Input 1..5 goes from Low to High. You may want to use these macros to indicate an alarm condition. These macros are only called if the input alarms are enabled with command 092 (see Chapter 12). The input lines are the same as the analog lines. Use the input line functions to read contact closure conditions.

Macro	Definition
249	Input 1, Low to High
250	Input 2, Low to High
251	Input 3, Low to High
252	Input 4, Low to High
253	Input 5, Low to High

Macros 254..258 are called when Input 1..5 goes from High to Low. You may want to use these macros to indicate an alarm condition. These macros are only called if the input alarms are enabled with command 092 (see Chapter 12). The input lines are the same as the analog lines. Use the input line functions to read contact closure conditions.

Macro	Definition
254	Input 1, High to Low
255	Input 2, High to Low
256	Input 3, High to Low
257	Input 4, High to Low
258	Input 5, High to Low

Macros 259..261 are called when the Time-Out Timer expires. You may want to program these messages to indicate when a time-out condition occurred. They default to speaking "One Time Out" (or whatever receiver it is that just timed out). To adjust the time out timers, see Command 020.

Macro	Definition
259	Port 1, Time-out Timer Message
260	Port 2, Time-out Timer Message
261	Autopatch, Time-out Timer Message

Macros 262..264 are called when the Time-Out Timer comes out of a time-out condition. You may want to program these messages to indicate that a time-out condition has just been cleared.

Macro	Definition
262	Port 1, Time-out Timer Message
263	Port 2, Time-out Timer Message
264	Autopatch, Time-out Timer Message

Macros 265..267. If you don't use preaccess, you can totally ignore these macros. Even if you do use preaccess, you don't have to worry about them. They are automatically renamed and programmed when you configure a port for preaccess with Command 070 or 071. If you are curious, however, read on. When a port is set to require preaccess (either with Command 070 or 071), these macros are automatically programmed and renamed. The access code ("*" for a repeater, "#??" for a link) is actually the new name of these macros. Also, the command decoder is told to ignore every command that is entered from that port except for these macros. When you enter the access code, one of these macros is executed. The commands that are automatically programmed into these macros may do a lot of things (such as start dial tone for a link), but they always do this one thing, they execute Command 074. Command 074 tells the command decoder to let that port access all of the commands in the controller again, but only until the preaccess timer (see Command 020) runs out.

You should never have to change the contents of these macros by hand (since Command 070 and 071 do the work for you), but you might want to change their names. When you use Command 070 to configure a port as a preaccess repeater, it assumes that you want the local-mode access code to be "*". If that is not true, you can simply rename the first preaccess macro for that port to something else. Similarly, the link access code that is usually "#" plus two digits, can be changed to any valid command name up to six digits long.

Macro	Definition
265	Port 1 Pre-Access Storage
266	Port 2 Pre-Access Storage
267	Autopatch Access Password

Macro 268 is called whenever the controller is reset, whether it is reset because the power was just turned on, because you pressed the reset button, or because you executed the remote reset command. You can use it to execute any commands that you want to be executed on reset. If you run out of space in this, or any other macro, because you are trying to do too much, just call another macro, or several of them, from this macro and split up the work.

Macro	Definition
268	Macro Called on Reset

Macro 269 is a temporary macro that is used when appending macros etc. It is of no use to you because it will be overwritten often.

Macro	Definition
269	System Temporary Macro

Macro 270..285 are called when the corresponding user timer (see Command 020) expires. These timers can be started with Command 022 and stopped with Command 023. They are not normally used, but are provided for users that have a special purpose for them. A more general and flexible system of user-definable timers is planned for a future release.

Macro	Definition	.	Macro	Definition
270	User Timer #00	.	278	User Timer #08
271	User Timer #01	.	279	User Timer #09
272	User Timer #02	.	280	User Timer #10
273	User Timer #03	.	281	User Timer #11
274	User Timer #04	.	282	User Timer #12
275	User Timer #05	.	283	User Timer #13
276	User Timer #06	.	284	User Timer #14
277	User Timer #07	.	285	User Timer #15

Macro 286 is automatically executed immediately before the autopatch is taken off hook when a call is made. It can be used to disconnect link ports before the call begins.

Macro	Definition
286	Called before Autopatch is taken Off Hook

Macro 287 is automatically executed immediately after the autopatch is hung up. It can be used to reconnect the links that were disconnected in macro 286.

Macro	Definition
287	Called after Autopatch is placed On Hook

Macro 288 is used to speak "Autopatch Busy" when you try to use the patch when it is already in use. It is automatically programmed when you set up the autopatch with Command 110. You can delete it and program your own autopatch busy message if you wish. If you wish to change this message (or any other macro 286..291) back to the default settings, just execute Command 110 again.

Macro	Definition
288	Called when the Autopatch is Busy

Macro 289 is used to speak "Autopatch" before the phone number is read back and dialed. It is automatically programmed when you set up the autopatch with Command 110. You can delete it and program your own message if you wish, but be sure that you recall the pre-programmed message first and understand what it does (it may do some other things depending on the number readback mode). You can also change the number of pauses that are spoken after the word "Autopatch" to change the delay before the number readback begins. See also macro 299.

Macro	Definition
289	Called before Autopatch number is read-back



Macro 290 is used to speak pauses after the number is read back. It is automatically programmed when you set up the autopatch with Command 110. You can change it if you wish, but be sure that you recall the pre-programmed macro first and understand what it does. You can change the number of pauses that are spoken to change the time that you can wait after the number is read back and still be able to kerchunk to make it dial/not dial (depending on the number readback mode).

Macro	Definition
290	Called after Autopatch number is read-back

Macro 291 is an autopatch macro that is used for number readback mode 2.

Macro	Definition
291	Internal Autopatch Macro

Macro 292 is used to speak "Autopatch Off" when you hang up the patch. It is automatically programmed when you set up the autopatch with Command 110. You can delete it and program your own autopatch off message if you wish.

Macro	Definition
292	Called when the Autopatch is hung-up.

Macro 293 is called when the DTMF cover tone is requested. It normally sends a 440 Hz tone using command 040. It can be set back to the default beep by entering: "053 293 020 030 0440". Any other tone, cw character, or voice message could also be used, although you will want to keep the length fairly short.

Macro	Definition
293	DTMF cover tone macro

Macro 294 is called when a user logs on using his password. First his callsign is spoken, then this macro is called. It is normally programmed to speak "control up". It can be programmed to speak other messages if you wish.

Macro	Definition
294	User Logon Message

Macro 295 is called a user tries to log on but gets the password wrong. It normally says "fail".

Macro	Definition
295	User Logon Fail Message

Macro 296 is called when a user logs off. First his callsign is spoken, then this macro is called. It is normally programmed to speak "control down".

Macro	Definition
296	User Logoff Message

Macros 297..298 are automatically programmed by command 048 when it sets up a beacon. If you are setting up beacons without using command 048, you can any macros you wish.

Macro	Definition
297..298	Beaconing Message Macros

Macro 299 is used to speak "Autodial" before an autodial call is made. It corresponds to macro 289 which is used for non-autodial calls.

Macro	Definition
299	Called before autodial number is read-back

Macro 300..399 are reserved for future applications

Macros 400..499 are user macros. They can be used for anything you want.

Chapter 9: Pre-Access Commands

What preaccess is:

Preaccess is a system used by several large linking systems to specify which controller in the network a DTMF command is intended to go to. A common configuration would be to enter the "*" key before commanding the local repeater, "#99" before commanding a distant controller via a link, and "#98" before commanding a different controller on the linking system. The advantage of requiring the user to "preaccess" a controller before commanding it is that you can use the same command names on each controller without confusion as to which one you are talking to. This is a very simplified description, but it should give you the idea.

What you need to know:

Because the preaccess system works quite differently from the way the RLC-Club normally works, there is a lot involved with changing back and forth. Commands 070 and 071 have been provided to make the conversion to preaccess easy and painless. If you have converted a port to preaccess and want to change it back, use command 072.

You always configure one port at a time for preaccess, so you can set up one port for preaccess and leave another port alone. This allows you to have a mixed system. This might be useful if you want to try out preaccess on one port without forcing all of the users of a repeater on a different port to change the way they do things. It also allows you to use the RLC-Club to interface between linking systems that do things differently.

049: Configure a Port's Tone Response when in Preaccess

This command allows the user to configure the frequencies of the tone response when in preaccess mode. Normal response is to send dial tone in certain modes and warble tones in other modes. The default response is dial tone.

```
<049> p xxxx yyyy
```

Parameters:

- 049 is the default command name
- P is the port to assign the tone response
 - 1 - Port 1
 - 2 - Port 2
 - 3 - Autopatch port
- XXXX is the first tone of the 2-tone combination
- YYYY is the second tone of the 2-tone combination

Default:

- XXXX is 0440 hertz
- YYYY is 0350 hertz

Response Name	Tone 1	Tone 2
Dial Tone	0440 Hertz	0350 Hertz
Warble	0440 Hertz	0480 Hertz

070: Configure a Repeater for Preaccess

This command sets up a port to be a preaccess repeater. To execute commands from the repeater, key up, press the '*' key and enter the command. The command will be executed immediately, without waiting for you to unkey. This allows you to execute multiple commands in sequence without unkeying after each one. Also, when you pressed the star key, you were removed from any other repeaters or links you may have been connected to. In other words, the '*' puts you into a local control mode. This mode will expire if you unkey for 8 seconds (see command 076).

If you key this repeater and do not press the '*' key, you will not be in the local control mode and will be connected to other ports normally (see Commands 000, 001 and 002).

```
<070> p
```

Parameters:

- 070 is the default command name.
- P is the port to make a preaccess repeater

071: *Configure a Link for Preaccess*

This command sets up a link to use the preaccess system. Links that are configured for preaccess will ignore any DTMF tones that are not preceded by Z..Z where Z..Z is the site access code you specify below. This allows commands to be sent down a linking system without every controller along the way trying to execute them, sending error messages, etc. To execute a command from such a link port, key up, enter Z..Z and the command. It will be executed when you unkey or press 'D'

```
<071> p y
z..z
```



Parameters:

- 071 is the default command name.
- P is the port to set up as a preaccess link
- Y is 0 for no dial tone when accessed, 1 for dial tone
- Z..Z is the site access code. Typical site access codes are "#11", "#75", "#99", etc., that is a '#' followed by two decimal digits. The controller will allow any preaccess code from 1 to 6 digits long with any of the 16 DTMF digits in it, although you may have to change your force-execution digit temporarily (see command 078) while you execute this command to use the force-execution digit as part of the access code.

072: Disable Preaccess Requirement for a Port

This command allows you to turn off preaccess as set with Commands 070 or 071. It sets the specified port back to factory defaults:

- Force-execution digit is 'D'
- Autoexecution is off
- Preaccess is off

It also restores the preaccess macro for that port back to factory defaults:

- Empty (contents are deleted)
- DTMF execution mask cleared

`<072> p`



Parameters:

- 072 is the default command name.
- P is the port for which to turn the preaccess requirement off (1..2)

073: Recall Ports with Preaccess Requirement

This command allows you to determine which ports require preaccess.

`<073>`

Parameters:

- 073 is the default command name.

074: Allow Access To a Port that Requires Preaccess

This command allows commands to be executed on the port the command is executed from until the preaccess timer which it starts (see command 020 for more info on timers) runs out. It is usually called from the preaccess macro (see Chapter 8) for that port so that when that preaccess macro is executed, it temporarily allows access to the rest of the commands in the controller.

`<074>`

Parameters:

- 074 is the default command name.

075: Set Stop Access Conditions

A port that requires preaccess is said to be "accessed" when an access code has been received. Typically this access code is "*" for a repeater port or "#" and two digits for a link. There are four things that can stop access to a port that requires preaccess after you have entered the access code. When any of them occur, you must enter the access code before that port will accept commands again. The first is the preaccess timer. It starts running when you enter the access code and is re-started whenever you release a DTMF digit. It will never expire while you are holding down a DTMF digit. When no digits have been entered for the length of the timer, it locks up that port. The other three conditions are optional - you can choose whether or not they will cause a port to be locked up.

- A command is executed or tries to execute and causes an error. If this condition is enabled, you will not be able to execute the access code once, then multiple commands. You will be able to enter the access code, one command, access code, one command...
- An error occurs because the digits entered are not a valid command name. If you make a mistake and this condition is enabled, you will have to enter the access code before you can try again.
- DTMF digits have been entered since the access code was entered and you unkey. This condition doesn't care how many commands you enter or whether they were valid or not; if you enter anything and unkey, you will be forced to enter the access code again.

This command allows you to choose whether these optional conditions will cause the ports to be locked up or not. Please note that the timer will always lock up the port after a period of no DTMF tones, these conditions just provide extra security if you want it.

```
<075> p x y z
```

Parameters:

- 075 is the default command name.
- P is the port for which to set the stop access conditions (1..2)
- X is 1 to enable / 0 to disable stopping access when a command is executed
- Y is 1 to enable / 0 to disable stopping access when an invalid command is entered
- Z is 1 to enable / 0 to disable stopping access when the receiver drops after a DTMF tone has been entered



076: Recall Stop Access Conditions

This command allows you to recall the conditions that will stop access on a port. See Command 075 for descriptions of the conditions.

```
<076> p
```

Parameters:

- 076 is the default command name.
- P is the port for which to recall the stop access conditions (1..2)

077: Isolate a Port from the Rest of the System

This command breaks the audio and ptt links between the specified port and all other ports in the system until the preaccess timer (which it starts) runs out. It temporarily overrides but does not change the crosspoint connections you may have set with Commands 000 and 001. It is useful for isolating a port while you enter local control commands without the tones going down any connected links. It is usually called from the preaccess macro of a port configured as a repeater. This macro is usually named '*', the local control key.

```
<077> p
```

Parameters:

- 077 is the default command name.
- P is the port for which to allow access (1..2)

Chapter 10: Scheduler

How the Scheduler Works:

The scheduler provides you with the ability to have up to 100 events occur automatically at hourly, daily, weekly, monthly or yearly intervals. The information used to store when event is supposed to occur and what it is supposed to do is stored in a "scheduler slot". The information about each event you want to set up must be stored in a different scheduler slot. You can change the contents of a scheduler slot by simply programming something different into that slot. Each event can call one command or user macro. If you call a macro, you can execute as many commands as you want in response to that scheduler event. You can use command 084 to keep a scheduled event from happening (disabling it) and to re-enable it later. Programming is explained in the command descriptions.

082: Set Up a Scheduler Event

This command sets up when a scheduler event will occur and what will happen at that time.

<082> ss ccc mm	Hourly Event
<082> ss ccc hh mm p	Daily Event
<082> ss ccc w hh mm p	Weekly Event
<082> ss ccc dd hh mm p	Monthly Event
<082> ss ccc nn dd hh mm p	Yearly Event

Parameters:

- 082 is the default command name.
- SS is the number of the scheduler slot to set up [00..99]
- CCC is the number of the command to be executed by the scheduler

Note: The command that the scheduler executes must not require any data (like is normally entered after the "*" key), because there is no way to supply that data. If you want the scheduler to execute a command that requires data, you must make the scheduler call a user macro, then program that macro to call the command with the appropriate data.

- MM is how many minutes after the hour the event will occur
- HH is the hour that the event will occur (12 hour time)
- P is 0 to indicate A.M. or 1 to indicate P.M.
- **W is the day of the week**

Number	Day
1	Sunday
2	Monday
3	Tuesday
4	Wednesday
5	Thursday
6	Friday
7	Saturday

- DD is the day of the month
- NN is the month of the year



Note about audio responses:

The default audio routing variable for commands executed by the scheduler is set by command 050. If you want to change where the audio goes, either change the default with command 050 or change it inside of a macro with command 037.

Example #1 (hourly):

You want to have the controller speak the time (command 026) at the top of every hour. We will program an hourly event in scheduler slot 00 to execute command number 026 when the minutes are 00:

```
082 00 026 00 D or unkey or <Enter>
```

Example #2 (daily):

Next you decide that you don't want it to recall the time at night, just from 8 A.M. through 10 P.M. This is really two events, one to enable it in the morning, another to disable it at night. The command to enable or disable scheduler slots is 084. Because 084 requires data after the command name, we will have to call it from a macro. First we will write the macros to enable and disable reading the time, then we will make the scheduler call those macros.

053 400 084 00 1 D or unkey	Make macro 400 enable scheduler slot 00
053 401 084 00 0 D or unkey	Make macro 401 disable scheduler slot 00
082 01 400 07 30 0 D or unkey	Program scheduler slot 01 to execute command 400 at 7:30 A.M. every day
082 02 40110 30 1 D or unkey	Program scheduler slot 02 to execute command 401 at 10:30 P.M. every day

Example #3 (weekly):

Friday (day 6 to the scheduler) at 5:00 P.M. you want the message "TGIF" (word numbers 050, 037, 039, 036) spoken out both radio ports on the controller. Again, we need to use a macro (number 402 for this example) to set the audio routing mask to all ports and speak the message:

053 402 037 12 D or unkey	Program macro to set audio routing variable to all radio ports
056 402 036 050 037 039 036 D or unkey	Append macro to speak voice message "TGIF"

Now we will program weekly scheduler event 03 to execute macro 402:

```
082 03 402 6 05 00 1 D or unkey
```

Example #4 (monthly):

One minute after midnight on the first day of each month, you want the controller to speak "this is" then the name of the month out ports 1 and 2. The word numbers for "this is" are 353 and 205. We will use the variable word number 309 to speak the current month (see Appendix B for word numbers). To program macro number 403, we enter:

053 403 037 12 D or unkey

Program macro to set audio routing variable to ports 1 and 2

056 403 036 353 205 509 D or unkey

Append macro to speak "this is" and the name of the month

Now we will make scheduler slot 04 call macro 403 monthly on the first day of the month at 12:01 A.M.

082 04 403 03 12 01 0 D or unkey

Example #5 (yearly):

You want to turn DTMF mute off on the repeater on port 1 at 10 minutes after noon on April fools day. First we program macro 404 to call command 007:

053 404 007 1 0 D or unkey

Macro will call command 007

Then we program scheduler slot 05:

082 05 404 04 01 12 10 1 D or unkey

083: Recall a Scheduler Event

This command recalls when a scheduler event will occur and what will happen at that time.

```
<083> ss
```

Parameters:

- 083 is the default command name.
- SS is the number of the scheduler slot to recall [00..99]

Explanation of the voice response:

"S ?? On/Off" Recalling Scheduler slot ?? and stating whether it is enabled (see command 084).

"C ????" When the scheduler event occurs, it will execute command number ???.

"Frequency ?" How often the event happens

4 - hourly

3 - daily

2 - weekly

1 - monthly

0 - yearly

From this point on, the response depends on the frequency.

Hourly:

"?" How many minutes after the hour the event happens.

Daily:

"Time ??????" What time of day the event happens.

Weekly:

"?????" The day of the week.

"Time ??????" What time of day the event happens.

Monthly:

"D ?" What day of the month the event happens.

"Time ??????" What time of day the event happens.

Yearly:

"?????" The month of the year that the event happens.

"D ?" What day of the month the event happens.

"Time ??????" What time of day the event happens.

084: Enable/Disable a Scheduler Event

This command allows you to temporarily disable a scheduler slot, then re-enable it later without having to reprogram it from scratch.

```
<084> ss c
```

Parameters:

- 084 is the default command name.
- SS is the number of the scheduler slot to recall [00..99]
- C is 1 to enable the event, 0 to disable it

Chapter 11: The ID System

How the ID's Work:

Whenever an ID needs to be sent, a macro is called automatically by the controller. Those macros can be programmed to do anything, but typically they send a voice or CW message. There are six different ID macros for each port, one initial ID macro, four pending ID macros, and one impolite ID macro. While you could program all of your ID macros to send the same message, it adds variety to make them different. The initial ID macro is called the first time the repeater is kerchunked after not being used for a while. It is usually programmed to send a relatively long descriptive voice message. Each of the pending ID macros gets called occasionally during a conversation. They are usually programmed to send a shorter voice ID. The controller can either rotate through them or do them in random order (see command 087). The controller tries to wait until you unkey to send an initial or pending ID, but if it is time to send an ID and you don't unkey, it has to ID while you are still keyed to stay legal. When this happens, the controller calls the impolite ID macro, which is usually programmed to send a CW message.

Polite Voice ID's:

When the controller is sending a voice initial or pending ID, you might want to be able to key up during that ID and have the controller switch to CW. This is known as a polite ID, and is set up by programming the ID macro to send a polite voice message (see command 064 for details).

Example:

We want to program the ID's for the repeater on port 1. The initial ID will be, "Welcome to the KC7HXB repeater in Sidney, the time is <time>". All of the pending ID's will be the same: "This-is the KC7HXB repeater". The impolite ID will be, "KC7HXB/R". This example is written as it could be typed into an upload file (see Appendix F). If entering it from a radio with DTMF, you can leave out the N's and everything following a ';':

```
; Initial ID:      Welcome to the KC7HXB repeater in Sidney, the time is <time>
                   N053 220 064 230 526 487 476 041 033 007 038 054 032 411 257 661 476 484
                                                           270 810

; Pending ID 1:   This-is the K   C   7   H   X   B   repeater
                   N053 222 064 230 480           476 041 033 007 038 054 032 411
; Pending ID 2:   This-is the K   C   7   H   X   B   repeater
                   N053 224 064 230 480           476 041 033 007 038 054 032 411
; Pending ID 3:   This-is the K   C   7   H   X   B   repeater
                   N053 226 064 230 480           476 041 033 007 038 054 032 411
; Pending ID 4:   This-is the K   C   7   H   X   B   repeater
                   N053 228 064 230 480           476 041 033 007 038 054 032 411
; Impolite ID:    K   C   7   H   X   B   /   R
N053 230 030      20 12 07 17 33 11 36 27
```

To Program Your Own ID's:

The following instructions and the above example should be enough to get your ID's programmed for port 1. More details about how everything works internally will follow, but aren't needed just to get started. The following commands can be entered either from a radio with a DTMF pad or from a computer or serial terminal.

```
053 220 064 230 <word numbers from Appendix B>
053 222 064 230 <word numbers from Appendix B>
053 224 064 230 <word numbers from Appendix B>
053 226 064 230 <word numbers from Appendix B>
053 228 064 230 <word numbers from Appendix B>
053 230 030 <CW characters from Appendix C>
```

To program the ID's for port 2, use the following:

```
053 221 064 231 <word numbers from Appendix B>
053 223 064 231 <word numbers from Appendix B>
053 225 064 231 <word numbers from Appendix B>
053 227 064 231 <word numbers from Appendix B>
053 229 064 231 <word numbers from Appendix B>
053 231 030 <CW characters from Appendix C>
```

As long as you want your initial ID's to be voice and polite and your impolite ID to be CW, you don't need to worry about what the above commands do. If you want to do something different, read the following section.

More about Programming ID's:

The above instructions for programming ID's are typical of how all of the macros in the controller can be programmed. It may look complicated at first, but it all follows a pattern. The 053 at the beginning of each line tells the controller to erase anything that might already be in the macro because you want to start over and put the following stuff in instead. The next three digits are the number of the macro. A list of all of the macros can be found in Chapter 8. Then comes the stuff that gets put into the macro. 064 and 030 are command numbers - you can look them up elsewhere in this manual - that speak polite voice messages and send CW messages. The rest of the line is information that is used by command 064 or 030 when the macro is executed. 064 need to know two things: what message to speak, and what to do if you key up during the message. The first three digits after the 064 is the number of the impolite ID macro, which is usually CW; that is what 064 does if you key up during the message. The rest of the digits are the word numbers that tell it what to say. 030 doesn't need to know what to do if you key up while it is sending CW, so it just needs to know what CW characters you want to send. Chapter 8 has more information about programming macros and commands 064 and 030 have more information about the information they need.

Some variations on these macros would be:

- Make all of the ID's CW. To do this, use 030 and CW character numbers rather than 064, just like the impolite ID macro in the example.
- Make the voice ID's do something besides the impolite ID CW message. To do this, put a

different command number after the 064 when you program the macro. That command will be executed if you interrupt the ID (but not if you are keyed when it is time for the ID to be sent - the impolite ID macro will be called in that case).

- Make the voice ID's just quit if you key up while they are being sent. To do this, just replace command 064 with 063 and remove the following three digits (063 doesn't need to know what to do if it is interrupted).
- Make the voice ID's impolite, that is make them keep talking even if you key up. To do this, just replace command 064 with 036 and remove the following three digits (036, like 063, doesn't need to know what to do if it is interrupted).
- Make the initial and pending ID's use the optional digital voice recorder. To do this, instead of using command 064, use 173 for the DVR1 or 184 for the DVR2 followed by the DVR track numbers you want to play. There is no way at this time to make the DVR ID's polite.

ID Timing:

You may have wondered how the controller knows when to send an ID. It uses three timers, the initial ID timer, the pending ID timer and the impolite ID timer (see command 020 for more timer information). The default values are 10 minutes, 9 minutes and 20 seconds, respectively. If it has been more than 10 minutes since the repeater was last used, the next time it is keyed up, the controller will try to send the initial ID. It will attempt to wait until you unkey so it can send the (typically) voice ID without it talking over you or switching to CW (if it is polite). It will wait up to the length of the impolite ID timer for you to unkey. If you do not unkey within this time, it will cancel the initial ID and send the impolite one instead. If you do unkey so it starts to speak the initial ID and that ID is programmed to be polite, keying up will make it switch to CW.

The pending ID timer is started whenever any ID is sent. When the pending ID timer expires, it checks to see if anyone has keyed the repeater since the last ID. If they have not, there is no need to ID - the last transmission was already ID'ed. If someone has keyed since the last ID, the controller starts trying to send a pending ID. Like with the initial ID, it will wait a while for you to unkey to avoid sending a voice ID while you are keyed up. If you unkey, it checks to see if you have chosen to have the pending ID's rotate through their cycle, or whether you want them selected randomly, and sends that ID. If you don't unkey before the impolite ID timer runs out, it calls the impolite ID instead.

To summarize, with the default timer settings, the controller will ID every 9 minutes during a conversation and one more time after the last time the repeater is keyed. If it can, it will send a voice ID; otherwise it will send a impolite CW ID. It will not ID at all if no one is using the repeater. You can change the ID timers if you want to, but make sure you set the pending ID timer to be shorter than the initial ID timer (at least a second) and that the length of the pending ID timer plus the impolite ID timer is less than 10 minutes (or whatever the legal maximum time between ID's is). The initial ID timer can be as long as you like. Since the only thing that causes ID's to be sent is someone keying up, you should also include your ID in messages that may be sent spontaneously such as scheduled messages (time on the hour for example) or analog alarms.

085: Enable/Disable IDing a Port

This command allows you to enable or disable the IDing functions for a port. Normally all ports are IDed, including link ports. Often this is not desired. This command allows you to turn off the IDing functions.

```
<085> p c
```

Parameters:

- 085 is the default command name.
- P is the port for which to enable or disable the ID's (1..3)
- C is 1 to enable ID's, 0 to disable them

Defaults:

IDs are enabled only on port 1.

Notes:

If you only want to disable some of the ID's for a port, keeping the pending ID's but not the initial ID, for example, just delete the ID macro that you don't want to do anything (see Chapter 8 for macro definitions).

086: Recall Which Ports have ID's Enabled

This command lists the ports that have IDing enabled. If all ports do, it speaks "12345678".

```
<086>
```

Parameters:

- 086 is the default command name.

087: Set Random or Rotating Pending ID's

This command allows you to select whether the four pending ID's for a port will be sent in random order or whether they will just be rotated through (1, 2 ,3, 4, 1, ...).

```
<087> p c
```

Parameters:

- 087 is the default command name.
- P is the port for the ID's (1..3)
- C is the ID control, 1 for random, 0 for rotating (default is rotating)

088: Recall Random or Rotating Pending ID Selection

This command allows you to recall which ports rotate through the pending ID's (1, 2 ,3, 4, 1, 2, 3, 4, 1, 2, ...) and which ones select them in random order. Voice response will list the ones that rotate, the others are random.

```
<088>
```

Parameters:

- 088 is the default command name.

Chapter 12: I/O System

About the I/O System:

The RLC-Club supports eight logical outputs (Requires the RLC-Club Deluxe Module) and 4 analog input lines. They are all handled totally separately in software; each command applies to only one of the three types of lines. Each type will be described below.

Please note that you can control how often the RLC-Club checks the input line and analog alarms by using Command 020 to change the reset value of timer 034. The default is to check the alarms once per second.

Logical Output Lines:



The logical outputs are supported only with the RLC-Club Deluxe module. The logical outputs are "open collector" outputs. That means that they can connect the output line to ground (turn it on) or disconnect it (turn it off). The output lines never output any voltage. The way they are commonly used is to connect one lead of the coil of a relay (or whatever else you want to control) to 12 volts and the other lead to an output line. When the output is turned on and applies a ground, the coil of the relay will be energized and will turn the relay on. The output line can "sink" (apply a ground of) about 150 milliamps. Connecting an output line directly to a power supply and turning it on will destroy the output driver IC. Make sure that whatever you are turning on and off draws less than 150mA.

The output lines can be turned on and off with Commands 093 and 094. You can recall whether a line is currently on or off with Command 095. If you want to speak a custom message when you turn an output on or off, program one of the user macros to speak the message you want, execute Command 038 (to suppress the rest of the voice responses), and then turn the output line on or off.

Analog Input Lines:

The analog input lines are designed to read a voltage within the range of 0 to 5 volts.

The RLC-CLUB provides a lot of flexibility in how it reads the analog input lines. Unfortunately, this also makes things a little bit complicated. Charts have been provided so that you can use the analog input lines without understanding how all of the math works, but if you have a unusual application, the RLC-Club can handle that as well. The following paragraphs explain what some of the options are when reading analog lines. The way you select from those options is described with the commands themselves.

"**Resolution**" refers to how many digits after the decimal place you want to know about. Temperature is usually read to the nearest degree, zero digits after the decimal. When reading a battery or power supply's voltage, you probably want to hear more than "thirteen volts" or "fourteen volts", something like "thirteen point six volts". To obtain this kind of reading, you would specify one digit after the decimal point.

The "**conversion ratio**" specifies how the controller interprets the voltage it detects. It could also be called the "scale" or "meter faceplate". If you are measuring wind speed, you may want a reading that varies from zero to 100 MPH. If wind direction, zero to 360 degrees. If pH, zero to 14. If temperature, way below zero to a hundred degrees or more. No matter what scale you want the reading to use, the voltage going into the analog line must be between 0 volts and 5 volts. If you have a sensor to measure something in the physical world that can provide a voltage that varies between 0 volts and 5 volts, you can set up the conversion ratio to handle it. The point of this discussion is to make it clear that the controller does not care what the real-world quantity is, it just needs a variable voltage and the proper conversion ratio, and it can handle it. You tell the RLC-Club what the conversion ratio is by specifying two points:

The first is what real world quantity would cause the sensor to output 0 volts. In many cases this is zero. For example, if you are using a small motor with a propeller to detect wind speed and the wind is not blowing, you will get 0 volts. But what about temperature? If our sensor outputs 0 volts for zero degrees, how would we get negative temperature readings? The analog lines can only accept positive voltages. The answer is that we use a temperature sensor that outputs about 2.5 volts at zero degrees, less than that when below zero and more than that when above zero. So our first conversion point for temperature says that it would have to be 460 degrees below zero to get 0 volts out of the sensor.

The second point we set specifies what real world quantity would cause the sensor to output 5 volts. If your wind speed detector outputs 5 volts when the wind is blowing 150 MPH, this point would be 150. For the temperature sensor we use (the LM335), it would have to be 440 degrees out to get 5 volts out of the sensor.

"Calibration" refers to correcting for small errors in a reading. If your the controller tells you it is 85 degrees when it is 88, you can calibrate it to correct for the small error. If it is way off, you probably have the conversion set wrong.

You can also set "analog alarms". These will cause a macro to be executed whenever the value read on one of the analog lines goes above or below a preset value. See Commands 104..107 for more information.

Inputs Connector Pin-Out

Ground Reference

Function	Pin Number
Ground	5
"	6
"	7
"	8
"	9

Analog/Contact Closure Input Lines

Function	Pin Number	Typical Use	Other
Analog 1	1	Temperature or Contact Closure	With internal pullup resistor
Analog 2	2	Temperature or Contact Closure	With internal pullup resistor
Analog 3	3	Temperature or Contact Closure	With internal pullup resistor
Analog 4	Internal	Power Supply Voltage	Connected to power supply voltage with divider
Analog 5	4	S-Meter	No Pullup Resistor

Latched Output Lines on Deluxe Module (Same pinout as RLC-2)

Function	Pin Number	.	Function	Pin Number
Output 1	9	.	Output 6	3
Output 2	5	.	Output 7	6
Output 3	8	.	Output 8	2
Output 4	4	.	Ground	1
Output 5	7

090: Read Whether Input Line is High or Low

This command allows you to read the input lines on the analog input connector (they have internal pullups).

<090> 1	Read single input line
<090> 1..4	Read multiple input lines

Parameters:

- 090 is the default command name.
- L is the input line number (1..4)

Notes:

To provide customized messages for the input lines, see Command 091.

091: Execute Input Line High or Low Macro

This command is similar to Command 090. The difference is that instead of speaking the word "high" or "low", the high or low internal macro for that input line will be executed. This allows you to program custom messages such as "door open" and "door shut". See Chapter 8 to find the macro numbers for each input line.

<091> 1	Execute input line macro for 1 input line
<091> 1..4	Execute input line macros for multiple input lines

Parameters:

- 091 is the default command name.
- L is the input line number (1..4)

Notes:

Multiple input lines can be read with one call to this command by entering more than one port number here.

092: Enable/Disable Input Line Alarm

This command allows you to turn on input line alarms that will occur whenever an input line goes high or low. When the alarm occurs, it will execute the input line high or low macro. Note that these are the same macros that get executed by Command 091 whenever the input line is read. The high and low alarms can be enabled or disabled separately.

```
<092> l a c
```

Parameters:

- 092 is the default command name.
- L is the input line number (1..4)
- A is 1 for the high alarm, 0 for the low alarm
- C is 1 to enable the alarm, 0 to disable it

Note:

There is currently no command recall whether the input line alarm is turned on or off.

093: Turn Output Line On

This command allows you to turn an output line on. The outputs are active low open collector drivers, so on means that they apply a ground to that output. Off means that the output is open, or not hooked to anything. The outputs are only supported on the RLC-Club Deluxe interface.

<093> 1	Turn a single output line on
<093> 1..1	Turn multiple output lines on

Parameters:

- 093 is the default command name.
- L is the output line number (1..8)

Notes:

To provide customized messages when turning output lines on or off, use a macro that both executes this command and the speak voice message command (036).

094: Turn Output Line Off

This command allows you to turn an output line off. The outputs are active low open collector drivers, so on means that they apply a ground to that output. Off means that the output is open, or not hooked to anything. The outputs are only supported on the RLC-Club Deluxe interface.

<094> 1	Turn a single output line off
<094> 1..1	Turn multiple output lines off

Parameters:

- 094 is the default command name.
- L is the output line number (1..8)

Notes:

To provide customized messages when turning output lines on or off, use a macro that both executes this command and the speak voice message command (036).

095: Recall Whether Output Line is On or Off

This command allows you to read the output lines on the deluxe interface. This command will tell you whether the output line is turned on or off. The outputs are only supported on the RLC-Club Deluxe interface.

<095> 1	Check a single output line
<095> 1..1	Check multiple output lines

Parameters:

- 095 is the default command name.
- L is the output line number (1..8)

Notes:

To provide a customized message when an output line is turned on or off, call Commands 093 or 094 from a macro that also speaks a voice message. There is no easy way to get a customized message to recall whether a line is on or off at the current time without turning it on or off again. If you really need custom recall messages and you are very familiar with macro programming, read the following, otherwise don't bother. The idea is to use a macro to call the output line on and off commands. Also in that on/off macro, call the program-single-command-macro command and program another macro (we will call it the recall macro) to speak the appropriate recall message. That recall macro could then be executed to find out whether the output line was turned on or off last. In other words, we would use the on and off macros to program the recall macro. Whichever on/off macro was executed last would have programmed the recall macro last, making it contain the appropriate message. If you didn't understand all of this, don't worry about it, use this command, and wait for a later software version that will make all of this easier.

100: Read Analog Input Line

This command allows you to read the analog input lines on the RLC-Club. The number that is read back will depend on three other things: the precision used (set with Command 101), the conversion scale (set with Command 102), and the calibration (set with Command 103). When you want to read the analog lines as part of a custom message such as "The temperature is ??? degrees fahrenheit" you should use the read-analog-input special words (see words numbered 800 and higher in Appendix B). They will allow you to read the input without all of the extra "Line ?" words that you won't want in your messages.

<100> 1	Read a single analog line
<100> 1..1	Read multiple analog lines

Parameters:

- 100 is the default command name.
- L is the analog input line number (1..5)

Notes:

Multiple input lines can be read with one call to this command by entering more than one port number here.

101: Set Resolution For Analog Input

This command allows you to specify how many digits after the decimal point will be used when reading each analog input line. If you want to read voltage to 1/10 of a volt, you specify one digit after the decimal point. This decimal point is assumed in the other analog commands since there is no good way to enter a decimal point on a DTMF pad. If you specify one decimal place with this command, the other analog commands will assume that the numbers you enter have an assumed decimal point one digit from the end. In other words, if you want to specify a value of 12 volts and you are using one digit after the decimal point, you must enter 120. The descriptions of those commands will explain this in more detail.

```
<101> l r
```

Parameters:

- 101 is the default command name.
- L is the analog input line number (1..5)
- R is the number of digits after the decimal point (0..3)

Explanation:

If you don't care what happens if you exceed the resolution of the converter, skip all of the following information and ignore this command. Please note that although you can specify as many as 3 decimal places, that doesn't mean that the analog to digital converter has that much resolution. It accepts a voltage between 0 and 5 volts (at the processor, the internal power supply voltage divider or external voltage dividers on the other lines can allow you to measure higher voltages) and can differentiate 1024 levels within that range, about 5mV per level. LM335 temperature sensors output a voltage of 10mV per degree Kelvin (Celsius - 273). This corresponds to about 5mV (10mV * 5/9) per degree fahrenheit which gives approximately one degree resolution (it is actually slightly better than a degree). There is no reason to try to read temperature with two decimal places when the actual resolution of the conversion is only to the even degree (0 decimal places), it would just add meaningless digits. Even one digit after the decimal point is pushing it - it would sound like you were getting 1/10 degree resolution even though you would really only be getting about 1/2 degree resolution. We recommend reading temperature to the nearest degree (0 digits after the decimal point).

Another example: reading battery voltage. Since the controller requires 12 or so volts to run, the processor's analog to digital converter cannot handle reading the power supply voltage directly. So input line #4 is connected to the controller's power input through a voltage divider. This divider uses a 40.2K and a 10K resistor, which divides the input voltage down to $10/(10+40.2) = 20\%$ of its original value. So with a 12 volt input, the converter actually sees 2.4 volts. To make the controller read the power supply voltage, we need to set it to convert the value read on a scale of 0..25 volts (5 volts * (10+40.2)/10). This can be done by entering

```
102 4 0 0000 0 0025 ;      read input 4 on 0 to 25 volt scale
101 4 0 ;                  read input 4 with no decimal places
```

If we want to read the battery voltage to the nearest 1/10 volt, we need to detect 10 times as many levels, 250 and use one decimal place:

102 4 0 0000 0 0250 ;	read input 4 on 0.0 to 25.0 volt scale
101 4 1 ;	read input 4 with 1 decimal place

Since the divider increases the voltage range that can be read on input 4 by 5 times, it also reduces the precision to 1/5 of what it is without the divider (from 5mV to 25mV). You can therefore read your battery voltage with one digit after the decimal point (100mV resolution) and waste a little resolution, or use two digits after the decimal point (10mV) and exceed the resolution of the converter. You can put an external voltage divider on input 5 to read external voltages in a similar way. To use inputs 1..3 with a voltage divider, you would need to disconnect the built-in pullup resistor.

Let us suppose that we using analog input #5 to to read the voltage supplied by a 3 volt battery pack with 3 digits after the decimal point (1mV resolution). Remember that the converter has only 5mV resolution (let us suppose it is exactly 5mV for this example). If the battery voltage is 3.002 volts, the converter will round it to 3.000. If the voltage is 3.003 volts, the converter will round it to 3.005. No matter what you do, the last digit read will always be 0 or 5. The number read back by the controller will sound like it has 1mV resolution, but the reading will only have 5mV resolution.

If all of this has confused you, ignore it and select 0 digits after the decimal point (or leave it alone if you haven't changed it - 0 digits is the default).

102: Set Conversion Ratio For Analog Input

This command allows you to select what scale the analog inputs are read on. This allows you to use the analog inputs to read temperature on a scale from hundreds of degrees below zero to hundreds above, battery voltage on a scale from 0 to 25 volts or wind direction from 0 to 360 degrees. Anything that can generate an analog voltage can be read on a scale appropriate to the measurement. Unfortunately, this flexibility brings with it a little complexity. To make it easy, we provide a chart of the common conversions you might use. If you want to use a conversion that is not listed, read the explanations after the chart and study the examples on the chart. Once you see the pattern, the calculations are not difficult.

Command Parameters	Description	Resolution
<102> x n wwww m zzzz	General conversion form
<102> 4 0 0000 0 0250	Internal Battery Voltage	0.1 volts, enter "101 4 1"
<102> x 1 0460 0 0440	Fahrenheit temperature	1 degree, enter "101 x 0"
<102> x 1 0273 0 0227	Celsius temperature	1 degree, enter "101 x 0"
<102> x 0 0000 0 0005	0.5 volts	1 volt, enter "101 x 0"
<102> x 0 0000 0 0050	0.5 volts	0.1 volt, enter "101 x 1"
<102> x 0 0000 0 0500	0.5 volts	0.01 volt, enter "101 x 2"
<102> x 0 0000 0 0025	0..25 volts	1 volt, enter "101 x 0"
<102> x 0 0000 0 0250	0..25 volts	0.1 volt, enter "101 x 1"
<102> x 0 0000 0 2500	0..25 volts	0.01 volt, enter "101 x 2"
<102> x 0 0000 0 0100	0 to 100%	1 percent, enter "101 x 0"
<102> x 0 0000 0 0360	0 to 360 degrees	1 degree, enter "101 x 0"

Notes:

- Please note that regardless of the conversion used, the voltage entering the analog inputs must be between 0 and 5 volts.
- For more information about hooking up a LM335Z temperature sensor, see Appendix H.

Parameters:

- 102 is the default command name.
- x is the analog input line number (1..5)
- n is 1 for negative, 0 for positive for the following number
- wwww is the reading with a 0 volt input with leading 0s if necessary
- m is 1 for negative, 0 for positive for the following number
- zzzz is the reading with a 5 volt input to the processor with leading 0s if necessary.

Custom Analog Conversion Ratios:

If the conversions provided in the chart are what you need, don't bother reading this section. It describes how to come up with your own conversions.

The conversion is simply a linear ratio. You provide a reading that corresponds with 0 volts at the processor and another number that corresponds with 5 volts at the processor, and the controller just does a linear interpolation.

First we will describe some of the conversions in the table, then illustrate how to come up with your own:



0 to 5 volt, 1 volt resolution, no voltage dividers:

This is about as straightforward as it can get. When it reads 0, it converts it to zero. When the processor reads 5 volts, it converts it to 5 volts.

0 to 5 volt, 1/10 volt resolution, no voltage dividers:

When it reads 0, it converts it to zero. To get 1/10 volt resolution, we need to use one digit after the decimal point. Because of this we have to assume one decimal point when we enter the conversion points. When the processor reads 5 volts, we need to convert to 50, which with one assumed decimal place, is 5.0 volts.

0 to 5 volt, 1/100 volt resolution, no voltage dividers:

When it reads 0, it converts it to zero. To get 1/100 volt resolution, we need to use two digits after the decimal point. When the processor reads 5 volts, we tell it to convert it to 500, which with one assumed decimal place, is 5.00 volts.

Temperature in Celsius, 1 degree resolution, no voltage dividers:

The key to figuring this one out is knowing how the LM335 temperature sensor works. It provides an output voltage of 10mV per degree Kelvin. It should therefore output zero volts at zero degrees Kelvin. Zero degrees Kelvin is minus 273 degrees Celsius, so that is our first conversion point, -273. The 5 volt conversion point would be reached at $5V/10mV$ per degree = 500 degrees Kelvin, or 227 degrees Celsius (above zero). This is our other conversion point.

Temperature in Fahrenheit, 1 degree resolution, no voltage dividers:

This conversion is very similar to the one for Celsius temperature. 0 degrees Kelvin is -460 degrees Fahrenheit. 500 degrees Kelvin is 440 degrees Fahrenheit.

0 to 25 volt, 1 volt resolution, with the voltage divider (input line 4):

The difference between this and the 5 volt conversion is the voltage divider. The divider cuts the received voltage to 1/5 before passing it on to the processor. In other words, the zero point does not change, but the full-scale reading is now 25 rather than 5 volts. Since we want it to read 25 volts when we give it 25 volts, the zero point is 0 and the full scale point is 25. Seems too easy, doesn't it?

The other resolutions of the 0 to 25 volt conversions are left to a comparison with the 5 volt conversions.

One more example will illustrate how to develop a conversion that is not listed in the chart. Let us assume that we want to read the wind speed at our site and that we have an anemometer (wind speed detector) that reads 10 volts at 100 MPH. Since the maximum voltage is above 5 volts we will need to use a voltage divider. To avoid having to disconnect the pullup resistors on inputs 1..3 (which is necessary to use a voltage divider with them), we will use input #5 and make our own external voltage divider. The divider will have the input voltage coming through a 40.2K resistor in series with a 10K resistor. The other end of the 10K should be hooked to ground. Input #5 should be connected to the point where the two resistors are joined, where the voltage should be about 1/5 what it is at the input of the voltage divider. We will assume that 0 volts are produced when the wind is not blowing and that it increases linearly from there. That sets our zero point to be zero. We must calculate our full scale reading as if it will occur at 25 volts, even though the sensor will never put out that much voltage, because that is the 5 volt full scale reading at the processor times the 5:1 voltage divider ratio. What we need to know is how fast the wind would have to blow to give us a 25 volt signal. A simple ratio will give us the answer:

$$\frac{100 \text{ MPH}}{10 \text{ volts}} = \frac{X \text{ MPH}}{25 \text{ volts}}$$

$$\text{Cross Multiplying: } 100 * 25 = 10 * X, \quad 2500 = 10 * X, \quad X = 250 \text{ MPH}$$

We now know that the low point is 0, the high point is 250, and that we need to use the voltage divider.

103: Calibrate an Analog Input

This command allows you to correct for small amounts of error in reading analog sources. It should not be used until the resolution and conversion ratios are set (with Commands 101 and 102). It is not intended to fix readings that are way off (more than 20 percent or so). If you are getting a reading that is a long way off, go back to Command 102 and correct the conversion ratio. This command accepts as input the correct value for an analog input line and adds or subtracts the right amount from the reading it is receiving to make it equal what you say it is. To get rid of this correction factor, execute the reset calibration form of this command shown in the table below.

<103> 1 n www	Calibrate an analog input
<103> 1 2	Reset calibration

Parameters:

- 103 is the default command name.
- L is the analog input line number (1..5)
- N is 1 for negative, 0 for positive for the following number
- WWW is the actual value that should be read by the sensor.

Notes:

The value you enter will have as many assumed decimal places as you set with Command 101.

104: Set an Analog Alarm

This command allows you to set an alarm that will occur when an analog reading goes below a low alarm point or above a high alarm point. When the alarm occurs, it will execute an internal macro (see Chapter 8 for internal macro definitions). You can program this internal macro to do anything, turn output lines on or off, speak a voice message, change your courtesy beep, etc. The alarm point will be checked at intervals determined by the length of the input alarm timer (see Command 020). When the analog reading comes out of alarm by the "Hysteresis" amount (set with Command 105), the analog alarm clear macro will be executed. You might want to program this macro to change an output line and/or speak an alarm clear message.

<104> l a n www

Calibrate an analog input

Parameters:

- 104 is the default command name.
- L is the analog input line number (1..5)
- A is 0 for a low alarm, 1 for a high alarm
- N is 1 for negative, 0 for positive for the following number
- WWW is the alarm point with leading 0s if necessary

Notes:

The value you enter will have as many assumed decimal places as you set with Command 101.

105: Set Analog Alarm Hysteresis

Hysteresis is a concept not everyone is familiar with, so let me illustrate it before I try to explain how to use it. Let us suppose that you are using one of the analog lines to read the temperature inside of your radio shack. In the winter, you want the controller to automatically turn the heater on and off to keep the temperature above 40 degrees. To do this you decide to control the heater with a relay that you can switch with one of the output lines. Next you set a low alarm at 40 degrees and program the low alarm macro for that analog line to turn the heater on and speak the message "low alarm". Now you need a way to turn the heater back off. To do this you use the analog alarm to normal macro to turn the heater off and speak the message "low alarm clear". This is where Hysteresis comes in. Do you want the heater to turn off at 41 degrees? This would probably make the heater turn on and off really often. It might be better if it warmed up to 45 degrees before the heater turned off, so it would turn on and off less often. The amount that it has to warm up past where the low alarm point was is the amount of Hysteresis, in this case 5 degrees. In the case of a high alarm (such as would be used to run an air conditioner, the amount of Hysteresis is how much the temperature would have to drop below the high alarm point before the alarm to normal macro would be executed. The amount of Hysteresis is the same for the high and low alarms (if this is not acceptable for your application, let us know). This command lets you set how much Hysteresis each analog line uses when determining whether the alarm is clear yet.

```
<105> L wwwww
```

Parameters:

- 105 is the default command name.
- L is the analog input line number (1..5)
- WWWW is the alarm point with leading 0s if necessary

Notes:

The value you enter must be a positive number and will have as many assumed decimal places as you set with Command 101.

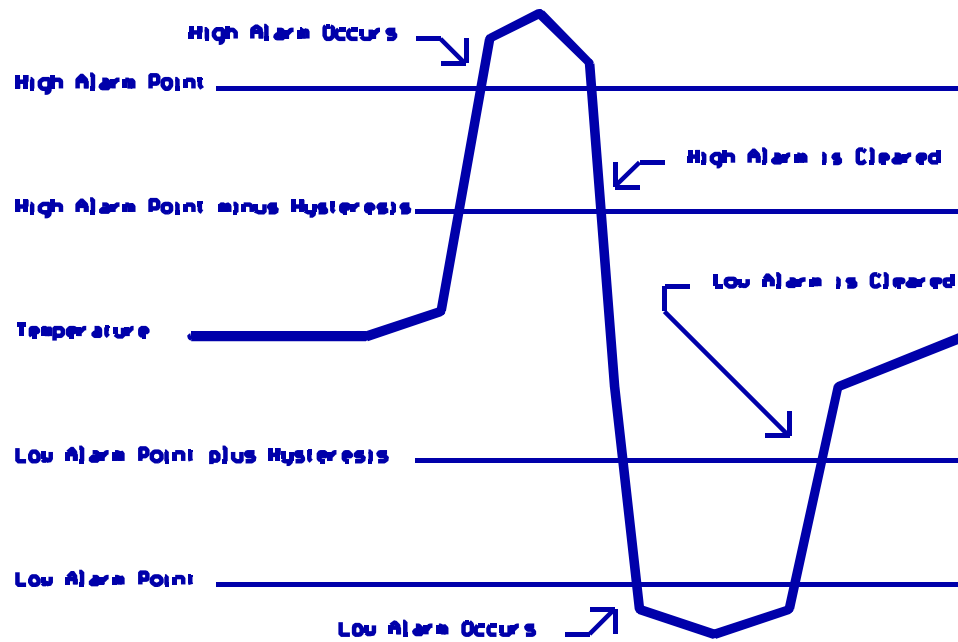

106: Enable/Disable an Analog Alarm

This command allows you control whether or not the analog alarms will occur without having to mess with the alarm points. This might be used to turn off a low temperature alarm while you are working at a site and have the door open or to disable turning a heater on when you are running on battery power. If an alarm is disabled, Command 107 will still tell you whether or not the line is in alarm, but the alarm macro will never execute.

```
<106> l a n
```

Parameters:

- 106 is the default command name.
- L is the analog input line number (1..5)
- A is 0 for a low alarm, 1 for a high alarm
- N is 1 to enable the alarm, 0 to disable it

107: Recall Analog Lines in Alarm

This command lists all of the ports in high alarm, then all of the ports in low alarm. It is helpful when trying to find out whether you have set the alarm points correctly.

```
<107>
```

Parameters:

- 107 is the default command name.

108: Recall Analog Line Configuration

This command recalls all kinds of information about an analog line's conversion, resolution, calibration, alarm points, Hysteresis, alarm enabled/disabled status, etc. It intended to aid in setting up the analog subsystem, not as a user command.

<108> 1

Parameters:

- 108 is the default command name.
- L is the analog input line number (1..5)

Description of the voice response:

- "analog ?" - which analog input on the I/O board we are referring to (1..5)
- "0 volts is ?" - the lower calibration point
- "5 volts is ?" - the upper calibration point
- "calibrate ?" - how many units the calibration changes the reading
- "low alarm ?" - the low alarm point
- "high alarm ?" - the high alarm point
- "h ?" - the amount of Hysteresis
- "low alarm ?" - whether alarm is on or off
- "high alarm ?" - whether alarm is on or off

160: Clear Analog High/Lows

This command allows you to reset the analog high/low values. They are reset to whatever the current value is. The readings can be read by speaking the appropriate word numbers (see Appendix B).

```
<160> a l.l
```

Parameters:

- 160 is the default command name
- A is 0 for the low value, 1 for the high value, 2 to clear both the low and high values
- L..L are the analog input lines

161: Set Analog Smoothing Factor

This command allows you to smooth the analog readings to "average out" noise and sudden changes.

```
<161> l ss
```

Parameters:

- 161 is the default command name
- L is the analog input line
- SS is the smoothing factor

Smooth Factor	Average Smooth Time
50	about 9 seconds
60	about 13 seconds
70	about 18 seconds
80	about 30 seconds
90	about 50 seconds
95	about 120 seconds
97	about 220 seconds
98	about 325 seconds
99	about 11 minutes

109: Configure Wind Speed Reading

This command can be used to tell the controller to count the pulses coming from an anemometer (those whirly things with three cups that spin in the wind) to determine the wind speed. It counts the number of pulses in a default of 2.26 seconds and treats that number like a voltage that could be read by an analog line. All of the normal analog commands will work with the resulting number: command 102 will control the scaling, command 100 will provide the current reading, the analog alarms can be used to notify you if the wind exceeds a certain speed, etc.

<109> 0	Don't calculate wind speed
<109> X	Use input line 'X' for wind speed

Details:

To read wind speed, hook up the anemometer so that the reed switch that closes as it rotates connects the input line on the controller to ground. Using a voltmeter or logic probe, make sure that the line pulses every time the anemometer goes around. The line can be connected directly to inputs 1..3, or to input 5 (on pin 4) if you use a 10K pullup resistor to 5 volts. Then use command 109 to tell the controller which input line it is connected to. From that point on, reading the analog line of that number will give you a number related to the wind speed. To make the controller read the wind speed in miles per hour, you will need to find out how fast your anemometer pulses relative to the wind speed. One common anemometer (Davis) is rated at 26.6 pulses per minute per mile per hour. $60/26.6 = 2.2556$ seconds to get one pulse per mile per hour. The wind speed timer is set to count the pulses in 2.26 seconds. If the analog conversion ratio is left at the default 1:1 (it can be changed with command 102), the analog line will read the speed in miles per hour. The wind speed measurement can be adjusted by changing the timer or by changing the conversion ratio with command 102. Using the calibrate command for wind speed is not recommended, as any calibration offset will keep it from reading zero when it is calm. You can use command 100 or the analog special words to make the controller speak the wind speed.

Chapter 13: Autopatch Routines

Configuring the Autopatch:

Command 110 allows you to specify whether or not you want the autopatch to read back in the synthesized voice the number it is about to dial. If you select to have the number read back, you can choose whether it should read it back "politely" (so it can be interrupted by kerchunking) or "impolitely" (so it always reads back the whole number).

Autopatch Up Commands:

There are three different commands that can be used to access the autopatch. All of them connect the port that the command was entered from to the autopatch. Because of this, none of them can be executed from the serial port or by the scheduler (how do you connect an autopatch to a scheduler?). They are:

- **Manual Off Hook:** Command 111. This command connects the radio port to the phone line without dialing any numbers. You can dial phone numbers without DTMF regeneration by executing this command, waiting for dial tone, and entering the number on your DTMF pad. Since the tones are not captured and regenerated but go out directly onto the phone line, there is no long distance checking, etc.
- **Normal Forward Dial:** Command 112. This command is the one you would usually make available to users. Three digit numbers will access autodial slots, 4 through 11 digit numbers will be checked against the dialing tables (explained later), then regenerated over the phone line. If you have specified pre-dial digits (such as a '9' to get out of a local PBX) with Command 116, they will be dialed first.
- **Special Forward Dial:** Command 113. This command is similar to the normal forward dial but it bypasses the dialing table checks. It is the most convenient way to bypass all of the long distance checking. It will dial any predial digits that you have programmed with Command 116.

Using '*' for the Autopatch Up Command:

You can use the '*' digit to execute any of the above autopatch commands. Simply rename your autopatch command to a '*' using Command 010. This will allow you to use the patch by simply keying up, pressing '*', then the phone number you wish to dial.

Hanging Up:

No matter which command was used to bring up the autopatch, Command 114 will hang it up. If you want to have more than one hang up command, just make several different macros call Command 114. You can rename command 114 to '#' by entering "010 114 #" unkey, 'D' or <Enter>.

Command 115 can also be used to hang up the patch. It differs from command 114 in that it will not hang up the patch from a radio port that is not part of a call in progress. For example: port 1 and port 2 are running independent repeaters (they aren't connected), and port 1 makes an autopatch call. Port 2 continues to operate normally, unaware that the autopatch is in use. Then someone on port 2 decides to make a call on the patch and gets the autopatch busy message. Rather than waiting for the user on port 1 to finish their call, the person trying to make a call on port 2 decides to hang up the patch so he can make his own call. If he uses command 115, the controller will not hang up the patch because port 2 is not connected to the autopatch. If he uses command 114, it will. Either command will work to hang up the patch if they are entered from port 1, the port that made the call. Often command 115 is used as the primary hang up command and command 114 is reserved as a control operator command, to be used only when an emergency mandates hanging up someone else's call. Resetting the controller with command 035 also hangs up the patch and can be executed from any radio port.

Connected Ports:

Any ports that are connected to or monitoring the port you make the autopatch call from will also be included in the autopatch call. For example, if you have connected repeaters and someone wants to make a call from one of them, you can bring the patch up for them from the other one.

Predial Digits:

Autopatches that are on a PBX often have to dial a '9' or some other combination of digits to reach the outside world. The RLC-Club has the ability to dial these digits for you. You can tell it what digits to dial and how long of delays to use before and after these "predial digits" with Command 116. These digits will be dialed before every number that is dialed with the forward dial commands. You can chose whether or not they should be dialed before each autodial number. This allows you to dial numbers that do not require the predial digits by putting them in an autodial slot.

The Autodialer:

There are 501 autodial slots that can each hold up to an eighteen digit phone number. They are numbered 000 through 500. They can be accessed by executing either of the forward dial commands with the number of the autodial slot you want to dial. They can be programmed with Command 124. You can find out what number is in an autodial slot with Command 125. You can select whether or not the predial digits (set with Command 116) get sent before the autodial number with Command 126. This is useful for those using a PBX because it allows them to have some autodial slots go to internal numbers and some to dial the predial digits to get to the outside

world. Command 127 allows you to enable or disable the use of an autodial slot. This allows you to keep an autodial number from being dialed without erasing the slot and having to re-program it later.

Limiting Call Length:

The time out timer for the autopatch port limits the total length of the call. If the timer expires, it will execute the autopatch port's time out macro (see Chapter 8) and hang the autopatch up. If you would like a message to be spoken when this happens, put the commands to speak that message in the time out macro. If you do not want the autopatch to time out, set the timer length to 9999 with Command 020. You will probably want to erase the contents of the time out clear macro for the autopatch port with Command 055.

You will be warned before the patch times out. Thirty seconds before timeout, three beeps will be sent out of the radio port and down the phone line (so both sides of the conversation know it). Two beeps are sent twenty seconds before, and one ten seconds before. *The CW characters 'S', 'I', and 'E' are used for these warning beeps.*

To reset the patch time out timer during a call, use Command 022 to reset timer 028 (see Chapter 4 for more information about timers) by entering "022 028" and unkeying. You could make macro 400 extend the patch timer using the code `**3` as follows:

```
053 400 030 18 D or unkey      ; send CW 'I' as a beep-beep response
056 400 038 D or unkey        ; be silent for rest of macro
056 400 022 028 D or unkey    ; reset timer 097
056 010 400 **3 D or unkey    ; rename macro 400 to '**3'
```

How the Dialing Tables Work:

The dialing tables are used to control which long distance numbers can be dialed with Command 112 and which cannot. They do not affect autodial numbers or numbers dialed with Command 113. If you attempt to dial a number with Command 112 that is not allowed you will get an error 213 (you can disable or change this error message by editing macro 213 - see Chapter 8). By default all numbers are blocked. Before a number is dialed using Command 112, it must pass the following tests:

- All digits in the phone number must be decimal digits. A, B, C, and D are not allowed; if you need to dial these digits, put them in as predial digits, use an autodial slot or use Command 113.
- If the number is one, two or three digits and is 500 or less, it will be treated as an autodial number. The autodial number will be looked up, and if it has been programmed, it will be accepted without checking to see if it is long distance or not. It is assumed that whoever programs the autodial slots will decide whether to allow long distance numbers in autodial slots or not.

- If the number matches one of the entries in the nuisance number table, it is blocked. Slot 000 defaults to blocking all three digit numbers and slot 001 defaults to blocking all four digit numbers. If you want to dial three or four digit numbers, clear those slots in the nuisance number table.
- If the number is five digits or longer and matches one of the entries in the allowed number table, it is accepted, otherwise it is blocked. Slot 000 defaults to allowing all seven digit numbers.

If the number passes all of the above tests and is accepted, it will be read back (if you turn number readback on with Command 110) and then dialed.

Both the allowed numbers table and the nuisance number table store each type of number in a separate "slot". Each slot affects only one length of number, so allowing all seven digit numbers will not affect six or eight digit numbers. You should keep track of what you put in each slot as you program them, so that you can easily change them later.

The allowed numbers table has 500 slots, numbered 000..499. Each slot can hold one type of number that you want to allow. For example, you might want to program slot 0 to allow seven digit numbers that begin with the prefix 482, such as 482-7515 and slot 1 to allow eleven digit numbers that begin with 1800. To do this, you could enter Command 119 000 482 D or unkey (where Command 119 is the name of the command that programs the allowed numbers table, 0 is the slot to store this type of number in, and 482 is the number we want to allow, ignoring the last four digits). If you instead wanted to allow all seven digit numbers, not just 482 numbers, we could enter Command 119 000 ### D or unkey instead. The # symbol is a wildcard digit that represents any decimal digit. To allow 1800 numbers (using slot 1 so we don't mess up the seven digit numbers we allowed in slot 0), we would enter Command 119 001 1800### D or unkey.

The nuisance number table allows you to block numbers that would otherwise be allowed. It has 100 slots, numbered 000..099. You may not need to use the nuisance number table. It is usually used to block prank calls. For example, we allowed all seven digit numbers in the allow table example above. If someone was calling our fax number (482-7547) with the autopatch as a prank, we could block that number by entering Command 121 000 4827547 D or unkey. Note that the nuisance number table is independent from the allowed number table; slot 000 in one table does not interfere with slot 000 in the other table. The nuisance number table requires that you enter all of the digits of the phone number; it does not ignore the last four digits like the allowed number table does. The nuisance number table accepts wildcards. Even if we had allowed all seven digit numbers in the allow table as in the examples above, we could block seven digit numbers beginning with 554 by entering Command 121 01 554##### D or unkey.

You can check the operation of the dialing tables at any time by either trying to dial a number with the forward dial command, or just *pretending* to dial it with Command 123. This command will tell you whether a number would be blocked by the dialing table or would be dialed, without actually using the autopatch. Command 123 will work even if you don't have an autopatch.

Other Commands that Affect the Autopatch:

Command 007 (see Chapter 3) allows you to turn the DTMF mute on or off for the autopatch port. While this does not affect the DTMF digits that are actually generated when the autopatch is dialing, it does have several other effects. See the note on command 007 for more information.

110: Configure the Autopatch

This command allows you to enable or disable the autopatch and allows you to choose whether and how the number is read back before it is dialed.

```
<110> e s
```

Parameters:

- 110 is the default command name.
- e is the autopatch enable/disable control. 0 - Disable the autopatch. 1 - Enable the autopatch.
- s is the readback style, described below. Modes 2 and 3 watch to see if you force the command to be executed by pressing the force-execution digit (defaults to 'D', see command 078) or kerchunk before, during, or shortly after the number is read back; if you do they will immediately quit reading the number back and either dial the number (mode 2) or abort dialing (mode 3). Also see the notes for more options.

S - Readback Style	Reads Number Back	If Kerchunked or Force Execution
0	Never	No Effect
1	Always	No Effect
2	Politely	Makes it Dial
3	Politely	Makes it Abort Dialing

Default:

- The autopatch system is enabled. Readback style is type '1' (read back before dialing).

Notes:

- You can adjust messages and the length of the delays before and after the phone number is read back by editing macros 286..292, after you execute this command to set them up.
- You can make the controller read the numbers back politely like mode two, but dial whether or not you kerchunk it, by entering using command 110 to select readback mode 2, then entering "056 290 291" to make macro 290 call macro 291 when it finishes. There is one known problem with doing this: if you do kerchunk it to make the message go polite, it will dial the number twice in a row. This usually won't be noticed but could be if someone answers the phone right away (on the first ring or so). If you are calling an answering machine, paging service or some other device that listens for DTMF digits, it could cause problems by entering digits you didn't want entered. To avoid that, either don't use this readback mode or don't kerchunk while it is reading the number back.
- If this command is executed while the patch is in use, it will hang the patch up.

111: Manual Off Hook

This command connects the port from which the command is executed to the autopatch without dialing any numbers. Touch tones from your radio can be used to dial numbers without DTMF regeneration. This is usually used only for testing, because it doesn't regenerate your DTMF digits, it doesn't allow you to block long distance numbers, and it usually causes an error message when you dial a number. The error message may be generated because the controller can't tell whether you are entering a command (such as to hang up the patch) or dialing a number, so it treats the number as a (usually invalid) command; you can just ignore the error message. Command 114 can be used to hang up the patch.

<111>

Parameters:

- 111 is the default command name.

112: Normal Forward Dial

This is the normal autopatch up command you would make available to your users if you want an open autopatch. If the number you enter is 3 digits or less, it dials that autodial number. If it is longer, it checks it against the dialing tables described at the beginning of this autopatch section and if it passes, dials that number.. Command 114 can be used to hang up the patch.

<112> sss	Autopatch using an autodial memory slot
<112> d..d	Autopatch using user entered number

Parameters:

- 112 is the default command name.
- SSS is the autodial slot number (1..3 digits)
- D..D is the phone number you want to dial

Notes:

- The longest number that can be dialed with the command is eleven digits, because that is the longest number that can be specified in the allowed number table. If you need to dial longer numbers, use Command 113.



113: Forward Dial with no Long Distance Checking

This is the autopatch up command you would use if you wanted to dial a number without worrying about whether or not it is allowed by the dialing tables. You would not normally make this command available to the average user, because it would allow them to dial any number, including long distance numbers.

<113> sss	Autopatch using an autodial memory slot
<113> d..d	Autopatch using user entered number

Parameters:

- 113 is the default command name.
- SSS is the autodial slot number (1..3 digits)
- D..D is the phone number you want to dial

Notes:

- You can call this from a macro to dial numbers too long to fit in an autodial slot.

Example:

Have macro 400 dial the number 012345678901234567890

```
<053> 400 113 012345678901234567890 D or unkey or <Enter>
```

The user will program macro 400 to bring up the patch and dial the number 012345678901234567890.

114: Hang up the Autopatch

This is the command to use to hang up the autopatch, no matter which of the three autopatch up commands you used to take it off-hook.

```
<114>
```

Parameters:

- 114 is the default command name.

Note:

- The autopatch is also hung up whenever the controller is reset.

Example:

I want my autopatch hang-up code to be '#'

```
<010> 114 # D or unkey or <Enter>
```

Now the users will enter '#' to hang-up the autopatch.

115: Possibly Hang up the Autopatch

This command normally works exactly like command 114, but it won't allow you to hang up the patch if someone else on another radio port is using it and you aren't. Command 114 will hang up the patch if it is any use by any port; that is you can hang it up even if someone else on another port of the controller that is using it. It is important to be able to do that if there is an emergency and you need to cut them off. On the other hand, if someone tries to use the patch and gets the "autopatch busy" message, they may not realize (or care) that someone else is using the patch even though they can't hear it, and they may hang it up. Giving the users access to command 115 rather than 114 will solve that problem, as only the port(s) that can hear the autopatch call will be allowed to hang it up. If they try to hang it up with this command while someone else is using it, you may want to speak a message that indicates that they aren't allowed to do that. Event trigger 097 (see Chapter 20) will let you do that.

```
<115>
```

116: Set / Recall the Predial Digits and Timing

When either of the forward dial commands are used, several things must take place before the number is actually dialed:

- If number readback is turned on, speak the number.
- Take the phone line off-hook. This is the same as you picking up your phone at home.
- Since the controller can not listen to see if it gets dial tone from the phone line, it just delays for a little bit and assumes that dial tone is there. We will call this delay the "initial delay".
- If you must dial '9' or some other digits to get out of a local switchboard or PBX, those digits should be dialed here. We will call those "predial digits". You can also use these predial digits to dial special codes to turn on or off call waiting, caller ID, and other special features that your phone company may offer. They can be omitted if you are not on a PBX.
- After dialing the predial digits, you may need to delay again while the PBX hooks you up to an outside telephone line. We will call this delay the "after-predial delay". This delay can be set to zero if you are not using predial digits.
- Now we can dial the actual number.

This command lets you set the initial delay, predial digits (if any), and after-predial delay.

Recall Settings	<116> 0
Change Settings	<116> iii aaa d..d

Parameters:

- 116 is the default command name.
- III is the length of the initial delay in 10mS increments (001..250). Default is 100. Do not set to 0.
- AAA the length of the after-predial delay in 10mS increments (001..250). Default is 100. Do not set to 0.
- D..D are the predial digits. They can be omitted. The maximum number of predial digits is 10. Any of the 16 DTMF digits can be used, although you might have to temporarily change your force-execution digit to use it (see command 078).

Defaults:

Initial delay = 100 (1 second)
 After-predial delay = 100 (1 second)
 Predial digits = none



119: Set Allowed Numbers Table Slot

This command allows you to set one of the slots in the allowed numbers table. For a description of this table and how to use it, see the explanation of the dialing tables before Command 110.

<119> sss	Clear slot sss
<119> sss d..d	Program slot sss

Parameters:

- 119 is the default command name.
- SSS is the slot number (000..499)
- D..D is the area code/prefix (do not include the last four digits of the phone number). The '#' digit is a wildcard that matches any digit.



Defaults:

- Slot 000 is programmed to “###”, which allows all seven digit numbers.

120: Recall Allowed Numbers Table Slot

This command allows you to recall the contents of one of the slots in the allowed numbers table. For a description of this table and how to use it, see the explanation of the dialing tables before Command 110.

<120> sss

Parameters:

- 120 is the default command name.
- SSS is the slot number (000..499)

121: Set Nuisance Numbers Table Slot

This command allows you to set one of the slots in the nuisance number table. For a description of this table and how to use it, see the explanation of the dialing tables before Command 110.

<121> sss	Clear slot sss
<121> sss d..d	Program Slot sss

Parameters:

- 121 is the default command name.
- SSS is the slot number (000..099)
- D..D is the whole number to be blocked (do include the last four digits of the phone number). The '#' digit is a wildcard that matches any digit.

Defaults:

- Slot 000 is programmed to "###" to block three digit numbers and slot 001 is programmed to "####" to block four digit numbers.

122: Recall Nuisance Numbers Table Slot

This command allows you to recall the contents of one of the slots in the nuisance number table. For a description of this table and how to use it, see the explanation of the dialing tables before Command 110.

<122> sss

Parameters:

- 122 is the default command name.
- SSS is the slot number (000..099)
- D..D is the whole number to be blocked (do include the last four digits of the phone number). The '#' digit is a wildcard that matches any digit.

123: Test Dialing Tables

This command allows you to test the dialing tables. It takes the telephone number you enter and tests it in the exact same way the normal forward dial Command 112 does, but instead of dialing the number, it just tells you whether or not the number is rejected by the dialing tables. This comes in very handy when setting up the dialing tables, because you don't have to actually dial and hang up numbers to see if they are blocked or not. This command also works from the serial port, allowing you to check the dialing table from a terminal or computer. You do not have to have an autopatch installed to use this command.

```
<123> d..d
```

Parameters:

- 123 is the default command name.
- D..D is the number you wish to test with the dialing tables

124: Set Autodial Slot

This command allows you to set one of the autodial slots. For a description of the autodial slots and how to use them, see the autopatch section before Command 110.

```
<124> sss d..d
```

Parameters:

- 124 is the default command name.
- SSS is the slot number (000..500)
- D..D is the whole number to be dialed (up to 18 digits), not including any predial digits (they must be set with Command 116 - you can keep them from being sent for an autodial slot with Command 126).

Notes:

- You can clear the data out of a slot by entering Command 124 SSS D or unkey
- You can disable a slot without erasing it with Command 127.
- After you program an autodial memory, the predial information for that slot is enabled
- Autodial numbers are not checked by the long distance dialing tables

125: Recall Autodial Slot

This command allows you to recall the contents of one of the autodial slots.

```
<125> sss
```

Parameters:

- 125 is the default command name.
- SSS is the slot number (000..500)

126: Send Predial Digits / Callsign for Autodial Slot?

This command allows you to control whether or not the predial digits will be sent before an autodial number. The default is to send them. By telling the controller not to send them, you can dial extensions on the PBX you are on (numbers that don't need the predial digits) with an autodial slot. The initial delay and after-predial delay (see Command 116) are sent in either case.

It also allows you to control whether or not any callsigns you may have programmed for your users will be spoken when dialing their autodial slot. You may also want to assign autodial slots for emergency numbers and program their "callsign" to be something like "police". See command 191 for information about programming callsigns.

Set Predial Sending	<126> sss p
Set Callsign Sending	<126> sss p c

Parameters:

- 126 is the default command name.
- SSS is the slot number (000..500)
- P is 1 to send the predial digits (the default), 0 to not send them.
- C (optional, no change if omitted) is 1 to send the callsign for that autodial slot if it is programmed (the default), 0 is to just use the number of the autodial slot. The default callsigns are the number of the slot, spoken as separate digits like "two three zero". If you set C to 0, it will speak the number of the slot as a number, like "two hundred thirty".

Notes:

This command must be executed after you program an autodial position. The default setting for this command is predial enabled. If you have a predial number programmed, and you do not want the controller to add a predial your autodial slot number, then you must execute this command and disable the predial setting for that specific autodial number.

127: Enable/Disable an Autodial Slot

This command allows you to disable an autodial slot without erasing its contents so you can enable it later without having to re-enter the number.

<127> sss c

Parameters:

- SSS is the slot number (000..500)
- C is 1 to enable the slot (also done automatically when you program it), 0 to disable it

128: Set Full or Half-Duplex Patch Audio for a TX

This command allows you to control whether the audio from the autopatch gets muted when one of the receivers that can send audio to the patch is active. When the controller receives a command to bring up the patch, it connects that port and any ports that are monitoring or connected to that port to the patch, so they can all take part in the call. Each of those ports' transmitters will stay up for the length of the call. Each transmitter that is set for full-duplex mode with this command will transmit the audio from the autopatch for the entire length of the call; if it also transmits the audio from a receiver, it will mix it with the autopatch audio. Each transmitter that is set up for half-duplex mode (the default) with this command will mute the audio from the autopatch whenever someone keys up their radio to talk to the person on the phone. This allows the control op to mute anything that the person on the phone may say by simply keying up, rather than having to hang up the patch.

<128> p c	Set autopatch half-duplex mode for a port
-----------	---

Parameters:

- 128 is the default command name.
- P is the requested port (1..2)
- C is the Half-Duplex on/off setting
 - 1 ==> make the selected port half duplex (the default)
 - 0 ==> make the selected port full duplex

129: Recall Full or Half-Duplex Patch Audio for a TX

This command allows you to recall whether the audio from the autopatch gets muted when one of the receivers that can send audio to the patch is active. It lists the ports that are in half-duplex mode. If a port is not listed, it is in full-duplex mode.

<129>	Recall autopatch half-duplex mode for a port
-------	--

Parameters:

- 129 is the default command name.

133: Set up Reverse Patch

This command allows you to set up the reverse autopatch. You must set up the forward patch functions with Command 110 before you use this command. If you want to change how the reverse patch works, just execute this command again with the new information.

<133> 0	Disable reverse autopatch
<133> 1 xx y..y	Configure for over-air ringing
<133> 2 xx n..n	Configure for control mode

Parameters:

- 133 is the default command name.
- There are three reverse patch "modes".



Mode 0 disables the reverse patch. Forward patch will still work normally.

Mode 1 is the ring over air mode

XX - Number of rings the controller waits before ringing over the air.

Y..Y - What ports the ringing will be routed to

Mode 2 is the control mode

XX - Number of rings the controller waits before answering the phone.

N..N - Access code required when in mode 2 access

Note about Ring Detection:

This command automatically enables the keyup delay filter (see the description for the keyup delay timers in Chapter 4 for more information) for the autopatch port (port 4). This helps prevent transients on the phone line from fooling the controller into thinking the phone is ringing when it is not. If the phone line going to the controller rings in very short bursts, you may have to disable or shorten the keyup delay timer after executing this command to get the controller to answer.

Note on Mode 2:

After XX rings, the controller will answer the phone and give you about 9 seconds to enter the access code N..N, or it will hang up on you. If you enter the code N..N correctly the controller will speak "Control" and let you enter commands by DTMF just as you would from a radio port. Since you can't unkey to tell the controller to execute the commands, you will have to either use timed execution or change your force-execution digit for the autopatch from 'D' to '#' (see command 078). Note that you will have to have to rename any commands you wish to execute from the telephone to not contain the digits 'A', 'B', 'C' or 'D', as those digits can't be entered from most telephones.

After entering the access code, you can go out over radio ports or just monitor them by executing Commands 000 and 001. For example, if your autopatch is on port 8 and you wish to monitor the repeater on port 1, execute Command 001 81 D or wait if in timed execution mode. This will make the autopatch (port 8) monitor the repeater (port 1).

134: Access Reverse Patch Control Mode

You do not need to know about this command - it is for the controller's internal use when using reverse patch mode 2 (control mode), so you can quit reading now if you want. When the controller answers the phone in mode 2, the only commands you can execute are the pre-access macros for the autopatch port, because the controller turns preaccess on when you set up the patch. When you specify the reverse patch access code with Command 133, it renames one of the pre-access macros for that port to the access code and programs that macro to call this command when executed. This command allows you to access all of the commands until the patch is hung up, resets the patch time out timer, and stops the pre-access timer, among other things. If you accessing the reverse patch in mode 2 and the time out timer is about to expire, you can execute this command to keep the patch from timing out.



<134>

Parameters:

- 134 is the default command name.

135: Answer Reverse Patch

This command is used to answer a reverse patch call that is ringing out over the air (Autopatch needs to be configured as mode 1 - see Command 133). It will only work when the reverse patch is ringing - it is not a substitute for the manual off-hook command. The patch is hung up the same way as for forward patch, with Command 114.



<135>

Parameters:

- 135 is the default command name.

Notes:

If you try to execute this command and the reverse autopatch has not been ringing, you will get an autopatch error (See System wide errors at the front of the manual).

136: Set up Reverse Autopatch Ring

This command allows the user to set up the over the air ringing tone and length.

```
<136> xxx yyyy zzzz
```

Parameters:

- 136 is the default command name.
- XXX is the length of the ring tone
- YYYY is the Frequency of the first ring tone
- ZZZZ (optional) is the Frequency of the second ring tone

Defaults:

Ring tone length defaults to 2 Second
Ring tone frequencies default to 0440 Hz and 0480 Hz.

Example:

To set the ring back to the default: 136 200 0440 0480



Notes:

Do not make the length of the ring tone too long. The controller will stack up tone requests and could still be ringing over the air after the phone has answered if the length of the tone is longer than the delay between rings from your phone company.

137: Autodial Only



This is the same as the other dialing commands except it will only let you dial autodial numbers.

```
<137> sss
```

Parameters:

- 137 is the default command name.
- SSS is the autodial slot number 000..500 (1..3 digits)

Chapter 14: Doug Hall RBI-1 and RLC-ICM Routines

What the RBI-1 is:

Doug Hall Electronics' Remote Base Interface (RBI-1) allows the RLC-Club to control the Kenwood series TM-X21 and TM-X31 mobile radios. The RBI-1 converts the data output by the RLC-Club into a format that the radios can use. Up to four bands can be supported by one RBI-1 interface, with one band active at a time. PL (CTCSS) encode and decode is handled by the radios. The RBI-1 plugs into one of the RLC-Club's radio ports and uses three of the open collector output lines on the Club Deluxe module. The audio, COR and PTT interface is made through the RLC-Club's radio port and the signals that control the RBI-1 and ultimately the radio come from the output lines. More information about the RBI-1, including the address and phone number for Doug Hall Electronics, is included on the following pages. Link Communications does not sell the RBI-1 interface.

What the RLC-ICM is:

The RLC-ICM is a remote base interface for IC-900 and IC-901 band modules. The RLC-ICM uses the same data stream from the repeater controller as the RBI-1, except for the special setup codes sent with command 139. Up to four bands can be supported by one RLC-ICM interface. Unlike the RBI-1, more than one band can be active at the same time; up to all four bands can transmit or receive at the same time. The RLC-ICM also supports a Communications Specialists' TS-64 PL board for each band module. Each band that has a TS-64 can encode and decode PL. Different bands can use different PL frequencies. The RLC-ICM plugs into one of the RLC-Club's radio ports and uses two of the open collector output lines on the Club Deluxe module. The audio, COR and PTT interface is made through the RLC-Club's radio port and the signals that control the RBI-1 and ultimately the radio come from the output lines. The RLC-ICM is available from Link Communications.

Interfacing and Setup:

It is very easy to interface the RBI-1 or RLC-ICM to the RLC-Club. Directions for building the needed cable is provided on one of the following pages. You can build it yourself or order one from Link Communications, Inc.. The RBI-1 is connected to the radio's microphone connectors with cables supplied with the RBI-1. The RLC-ICM includes cables and small interface boards to connect to the IC-900/901 band modules. The only other connections are power, ground and antenna to the radios. The RBI-1 gets its power from the radio; the RLC-ICM has its own power plug.

If you are using the RLC-ICM, you will need to set it up with command 139. After that, all of the commands to set frequency, bands, etc should work.

Using the RBI-1 or RLC-ICM:

Using the RBI-1 or RLC-ICM (after it is set up) is very straightforward. There are separate commands to do each of the following tasks:

- 139: Setup RLC-Icom Interface
- 141: Set Band Unit for RBI-1 or RLC-ICM
- 142: Set Frequency and Optional Offset for RBI-1 or RLC-ICM
- 143: Set Offset for RBI-1 or RLC-ICM
- 144: Set Offset Format for RBI-1 or RLC-ICM
- 145: Set Power Level for RBI-1
- 146: Set PL Frequency for RBI-1 or RLC-ICM
- 147: Turn PL Encode Off/On for RBI-1 or RLC-ICM
- 148: Turn PL Decode Off/On for RBI-1 or RLC-ICM
- 149: Recall Band, Frequency and Offset for RBI-1 or RLC-ICM
- 150: Recall All RBI-1 or RLC-ICM Settings
- 151: Turn Radio Power On or Off for RBI-1
- 152: Goto Radio Memory for RBI-1

If there are combinations of settings that you use often, you can program them into the memories on the Kenwood radios (if you are using the RBI-1) or you can program user macros to select those settings, making the controller's macro work like a memory.

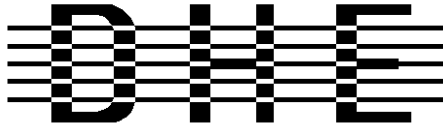

Doug Hall Electronics

815 E. Hudson St.
 Columbus, Ohio 43211
 (614)261-8871
 FAX 261-8805

INTRODUCTION

The DHE Remote Base Interface (RBI-1) Adapts the Kenwood series TM-X21 and TM-X31 mobile radios to several brands of Repeater Controllers. The RBI model 1 converts the serial data stream from the Controller and Directly controls the Kenwood Mobile radio. All connections to the Kenwood radio are made thru the microphone jack. In the maximum configuration using a Kenwood TM-701 Dual Band Mobile you can control Frequency, CTCSS encode On/Off, RF power level, Offset, Power On/Off, and Band. This is all accomplished thru the microphone jack.

The RLC-Club Format supports the following functions:

- Full frequency control, 4 ports/radios, and 4 bands.
- Transmitter power HI/MED/LOW
- CTCSS Frequency select, Encode on/off, Decode on/off.
 -20 and -12 Mhz offsets on 1200.

The Supported Kenwood Mobile Radios are as follows:

<u>140</u>	<u>220</u>	<u>440</u>	<u>1200</u>	<u>Dual Band</u>	
TM-221	TM-321	TM-421	TM-521	TM-621+	TM-721+
TM-231	TM-331	TM-431	TM-531	TM-631+	TM-731+
TM-241		TM-441	TM-541		TM-701+
+ Dual Banders					

SUPPORT CROSS REFERENCE

<u>FUNCTION</u>	<u>CTCSS ENCODE</u>	<u>CTCSS SELECT</u>	<u>CTCSS DECODE</u>	<u>MULTI BAND</u>	<u>RF PWR POWER</u>
GENERIC	Y	Y	Y	Y	Y
TM-X21	Y	N	N		N
TM-X31	Y	Y	Y		Y
TM-X41	Y	Y	Y		Y
TM-621/721	Y	N	N	Y	N
TM-631/731	Y	N	N	Y	N
TM-701	Y	Y	Y	Y	Y

Copyright (c) 1996 Doug Hall Electronics.
 All Rights reserved
 Specifications subject to change without notice

SPECIFICATIONS

Microprocessor: INTEL 87C51 Series 12MHz

Connections:

Power: RCA Phono + center pin.
 Controller: 9 Pin female "D" Connector
 Expansion: 9 Pin male "D" connector.
 Radios: 4 8 Pin Modular Compatible with Kenwood PG-4H cable.
 1 PG-4H provided. Additional cables available from Kenwood or DHE.

Adjustments: "T" (VR1) Radio transmit audio level adjust.
 "R" (VR2) Radio receive audio level adjust.

Audio: Radio Transmit 0.050V to 2.5V Input. (response controlled by capacitor removal)
 Impedance 15K.
 Radio Receive 0.020V to 2.5V Output. (response controlled by capacitor removal)
 Impedance 5K.

"S" Meter output: 0 to +5V 0V = no signal, 5V = > "S" 9.
 Output impedance approx 5K.

Expansion output: 8 outputs, ground active, Sink 500mA each, 1A maximum total.

Power Requirements: +10 to +14 Vdc @ 23mA.

Size: 1.5" X 5.1" X 5.5"

Copyright (c) 1996 Doug Hall Electronics.
 All Rights reserved
 Specifications subject to change without notice.

Installation

Place or mount the RBI-1 in close proximity to the Kenwood mobile radio to be used. Connect the RBI-1 with the provided PG-4H Cable from the 8 pin modular jack marked "RADIO" to the Kenwood Microphone jack. Only Port 1 (140/DUAL) will support a Dual Band radio. Port 1 is the only Port the 140 Mhz radio can be connected to.

The RBI will support all 4 bands (140/220/440/1200) as follows:

If Port one (on the RBI-1, not the controller) is filled, Port 2 is for 220 only, Port 3 is for 440 only, Port 4 is for 1200 only. Basically, if the selected band is unavailable on Port 1 it will go to the port assigned to that band.

Installation instructions are included with the RLC-ICM for connecting it to the IC-900/901 modules.

Building the RBI-1/RLC-ICM Cable

It is important to keep your interface cable as short as possible. The cable should never be more than 6 feet in length; shorter is better.

RBI-1 Connector J2 Pin# - Line Name

RLC-Club Connections Pin# - Line Name

<u>Connections to Outputs Connector on Deluxe Board</u>	
1 - RBI-1 RESET	Deluxe Board, Output #6 Pin 3
3 - Data	Deluxe Board, Output #7 Pin 6
4 - Clock/Strobe	Deluxe Board, Output #8, Pin 2
9 - Ground	Deluxe Board, Ground, Pin 1
	- This pin is required for noise suppression
<u>Connections to the radio port</u>	
5 - Kenwood TX Audio (T Pot)	4 - RLC-Club audio out
6 - Kenwood RX Audio (R Pot)	5 - RLC-Club audio in
7 - COS from Kenwood RX	7 - RLC-Club COR input (Active high)
8 - PTT to Kenwood TX	3 - RLC-Club PTT output
9 - Ground	1 - RLC-Club ground connection
2 - RLC-ICM (not RBI-1) PL Detect Out	2 - RLC-Club PL detect input (optional)
<u>Connections to Analog Inputs on Club (center DB-9)</u>	
2 - "S" Meter output	Analog Input on Club (optional)

In case it wasn't clear, there is only one connector on the RBI-1 that goes to the RLC-Club. It is connected to two different DB-9s on the RLC-Club. The audio connector goes to one of the radio ports, the RLC-Club Deluxe options output lines provide the serial control signals

Setup and Adjustment

The RBI-1 COR signal is active high. The RLC-ICM COR signal is active low. Set the COR polarity to active high with command 013.

Audio receive level from the Kenwood to the Controller is controlled by VR2 (R). The audio level from the Controller to the Kenwood is adjusted by VR1 (T). Refer to your manuals for additional adjustments in your controller.

Capacitor C5 (10uF) Inside the RBI-1 Interface must be removed and replaced with a 1uF/25V Tantalum Capacitor for the Audio to sound correct. Remove capacitors C16 and C17 to keep the audio from sounding too 'Bassy'.

Kenwood Radio Setup

The Kenwood radios need certain parameters set up before they can be controlled from the RBI-1, such as STEP. To make sure everything is set properly for use with the RBI-1, you should reset the radio to make sure all of the settings are set to the factory defaults. Instructions about how to do this can be found in your Kenwood operating guide or in the list below. This will erase the memories you have stored in the radio - you can enter them in again afterward.

TM-701	Hold the MR key down during power on to reset.
TM-X21	Hold the VFO/M and M.IN keys down during power on to reset.
TM-621/721	Hold the F key down during power on to reset.
TM-631/731	Hold the MR key down during power on to reset.
TM-X31	Hold the MR key down during power on to reset.
TM-X41	Hold the VFO key down during power on to reset.

Set the step size to 5KHz. (25Khz on 1200 Mhz units)

Set dual band radio to single band.

Set power to desired setting. Remember, remote base transmitters can have a high duty cycle because it will be transmitting during all activity on the Repeater side. The mobile radios used in a remote base configuration should be set to low power in most cases.

Set VFO/MEM to VFO for external frequency input.

Set CTCSS for desired frequencies. When using TM-X31/X41 series it will be set by the controller and will override your initial setting.

Set CTCSS Decode to off.

Set ABC and AL to off on models that support it.

Turn off Repeat functions.

Once these have been set, connect the Mike jack to the RBI. Reset the RBI to initialize the radio to the controller and get them in sync.

Any time there are manual changes from the radio front panel, the RBI and the Radio can get out of sync. This will require a RBI reset to correct. We recommend hooking the reset line from the RBI to an output from the controller. To reset the RBI-1, turn the output line on and back off. If you do not turn the line back off, the reset line will be held low, disabling the RBI-1. A macro can be used to let you toggle the output line with a single command.

Copyright (c) 1996 Doug Hall Electronics.

All Rights reserved

Specifications subject to change without notice.

139: Set Up the RLC-Icom Interface

The RLC-Icom interface allows the RLC-3 to control IC-900/901 band modules using the same commands as are used for the Doug Hall RBI-1. This command tells the controller which interface you are using (default is the RBI-1) and allows you to set up the RLC-Icom interface. This setup procedure is not necessary for the RBI-1, since it will only support one band module being on at a time.

Once you have set up the RLC-Icom with this command, you can use all of the RBI-1 commands (Commands 141..150) as described.

<139> 000	Set the controller for RBI-1 (the default)
<139> c ss	Set the controller for RLC-ICM

Parameters:

- 139 is the default command name.
- C is the connector number on the RLC-ICM that the module you are setting up is plugged into (1..4).
- SS is the setup code described below

Procedure:

- First tell the RLC-Icom which band module is plugged into each of its connectors. The setup codes are listed in the chart below. You will need to execute command C139 once for each setup code you wish to enter.

SS (the setup code)	Description
00	28 Mhz Module
05	50 Mhz Module
10	140..160 Mhz Module
15	220 Mhz Module
20	430..440 Mhz Module
25	1200 Mhz Module (not currently active)

The default setup for the RLC-Icom is to have connector 1 plugged into the 140..160 Mhz module, connector 2 plugged into the 220 Mhz module and connector 3 plugged into the 430..440 Mhz module. As an example, the following commands will enter those settings again:

Command 139 110 D or unkey or <Enter>

Command 139 215 D or unkey or <Enter>

Command 139 320 D or unkey or <Enter>

- Second, you must tell each band module what size of offset to use when you select a plus or minus offset with Commands 142 or 143. The setup codes follow:

SS (the setup code)	Description
30	100 Khz Offset
35	500 Khz Offset
40	600 Khz Offset
45	1 Mhz Offset
50	1.6 Mhz Offset
55	1.7 Mhz Offset
60	5 Mhz Offset
65	12 Mhz Offset
70	20 Mhz Offset

Example:

To select a 100 Khz offset for the 140..160 Mhz module that is plugged into connector 1, enter Command 139 130 D or unkey.

- Setup codes 75 and 80 are reserved for special offset memories, which are not yet supported.

- You should normally use Commands 000, 001 and 002 to control turning the remote base on and off and monitoring it. Those commands treat the whole RLC-Icom interface as one unit, connecting to and disconnecting from it the same way they would a link port. In addition to these commands, you can tell the RLC-Icom interface to enable transceive, enable receive only, or disable individual modules using the following codes:

SS (the setup code)	Description
85	Enable Transceive
90	Enable Receive Only (Transmit Disabled)
95	Disable Module Completely

Example:

If you wanted to monitor the 140..160 Mhz module and the 220 module, but only transmit on 140, you could enter Command 139 290 D or unkey to disable transmitting on the 220 module on connector 2 and Command 139 185 D or unkey to enable transceive on 140..160 Mhz (connector 1). If you then used Command 000 to connect the repeater port you were using to the port that the RLC-Icom is on, you would be able to transmit on and receive from the 140..160 Mhz module but only receive from the 220 Mhz module.

When you enter a new frequency, band, PL frequency, etc. with Commands 142 to 148, the module that is selected with Command 141 will automatically change to receive only mode (like you used code 90 above).

You will probably want to write macros to enable transceive after changing frequencies. The following commands will program macro 500 to enable transceive on the 140..160 Mhz module on connector 1 and name that macro to 12:

```
Command 053 500 043 D or unkey      ; be silent for the rest of the macro
Command 056 500 139 185 D or unkey  ; enable transceive
Command 010 500 12 D or unkey       ; rename macro 500 to 12
```

- If you have properly entered the above commands, the RLC-Icom is set up and ready to use. To enter frequencies, turn PL on and off, etc., use the RBI-1 commands in this section of the manual (commands 141..150).

RLC-ICM Internal Operation Test Points

The RLC-ICM ICOM IC900\901 module controller supports on-board function test points. These test points are supported in the software release V1.14 and later. The test points are located towards the center of the interface. Test points are located on connector J10 which is a 5 pin male header connector.

The following signals are present on J10.

Pin 1	-	Transfer complete (Data received without errors)
Pin 2	-	Configuration data received (Set-up data received without errors)
Pin 3	-	Error detected in transfer (Errors were encountered on the RLC-ICM)
Pin 4	-	1 second pulse output (Indicates program is running)
Pin 5	-	Ground reference

When any data is sent to the RLC-ICM one of the above pins will change state. The active state is +5v or a (high). More than one state may be present at a time and the states will be active for 10 seconds (Except the 1 second pulse output).

Controller interfacing:

The most common use for these signals is to read them with a voltmeter when troubleshooting the RLC-ICM. They could also be connected to input lines on the controller to provide remote feedback that commands were or were not transferred correctly, although this should not be necessary once the RLC-ICM has been interfaced and tested.

When a frequency is selected on the interface, and the data was received without errors, pin #1 will go from the low (0v) state to the high (5v) state. When connected to an input line the controller can respond (Remote Base OK) for example. If an error is received during transfer pin #3 will go from the low (0v) state to the high (5v) state. When connected to an input line the controller can respond (Remote Base Error) for example. These lines simply tell the user that the data was received.

These lines can not directly interface to LED's, relays or any current "hungry" device. They are only designed for correct/error detection.

141: Set Band Unit for RBI-1 or RLC-ICM

This command allows you to tell the Doug Hall RBI-1 or RLC-ICM which band unit you want to use. The valid band units are listed in the table below. Of course, you must have a radio that supports that band unit connected to the RBI-1 for this command to work. When you are going to a new frequency, you can just enter the frequency with command 142 and the band will be changed automatically.



<141> b..b

Parameters:

- 141 is the default command name.
- B..B is the band unit you want to select , (enter only as many digits as shown below)

B..B	RBI-1 Band Selected	RLC-Icom Band Selected
20	Not Available	20MHz (10 meters)
50	Not Available	50MHz (6 meters)
140	140MHz (2 meters)	140MHz (2 meters)
150	Not Available	150MHz
160	Not Available	160MHz
220	220MHz	220MHz
430	430MHz	430MHz
440	440MHz	440MHz
1240	1240MHz	1240MHz
1250	1250MHz	1250MHz
1260	1260MHz	1260MHz
1270	1270MHz	1270MHz
1280	1280MHz	1280MHz
1290	1290MHz	1290MHz

142: Set Frequency (and Offset) for RBI-1 or RLC-ICM

This command allows you change the frequency of the radios connected to the Doug Hall RBI-1 or RLC-ICM. After entering the command name (default is 142), you can just enter the frequency the way you would say it (ignoring the decimal point). To go to 147.38MHz, you could just enter "142 14738" and unkey. You do not need to enter 0's at the end unless you want to change the offset, in which case you have to enter three digits after the assumed decimal point before the digit that specifies the offset. For example, "142 1473801" would select a positive offset (using format 0, see command 144). The controller will determine what band the frequency is in and send the information to the remote base interface. The remote base interface figures out which radio handles that band's information and sends the frequency to that radio.

<142> 29xxf o	10 meter
<142> 5xxf o	50 Mhz
<142> 14xxxf o	144 Mhz
<142> 22xxxf o	220 Mhz
<142> 43xxxf o	430 Mhz
<142> 44xxxf o	440 Mhz
<142> 124xxxf o	1240 Mhz
<142> 125xxxf o	1250 Mhz
<142> 126xxxf o	1260 Mhz
<142> 127xxxf o	1270 Mhz
<142> 128xxxf o	1280 Mhz
<142> 129xxxf o	1290 Mhz

Parameters:

- 142 is the default command name.
- XXX is the new frequency (Mhz, 100Khz, 10Khz)
- F (optional) is the 5 Khz entry
- O (optional) is the new offset (see Command 143 for the format)

Notes:

- If you do not want to change the current offset, you can leave off the last few digits of the command as shown in the chart above.
- You can keep the controller from speaking the frequency by either entering or not entering a '*' as a "megahertz point", like "142 147*38". See command 144 for more information.

143: Set Offset for RBI-1 or RLC-ICM

This command allows you change the offset on the radio connected to the Doug Hall RBI-1. The offset is always specified as one digit, 0 to 3. There are two different common definitions of what digit corresponds with what offset. They are shown in the table below. The RLC-Club supports both. You can select which format you want to use with Command 144.

`<143> o`

Parameters:

- 143 is the default command name.
- O is the new offset

'Offset	Format 1	Format 2
0	Minus	Minus 20 (1200 only)
1	Plus	Minus
2	Simplex	Simplex
3	Minus 20 (1200 only)	Plus

Note:

You can recall the current band unit, frequency, and offset with Command 149.

144: Set Offset and Frequency Readback Styles

This command allows you change the way you enter the offset with Commands 142 and 143. The offset is always specified as one digit, 0 to 3. There are two different common definitions of what digit corresponds with what offset. They are shown in the table below. As an example, if you enter "142 147380 1" you will get a positive offset if you are using format 0 and a minus offset if you are using format 1.

This command also allows you to control under what conditions the controller will speak the frequency when you use commands 142 and 146 (PL frequency). By default, if the frequency is entered without a '*' ("142 14738" for example), the controller will speak the frequency ("one hundred forty seven point three eight") to confirm that it made the change. In some cases, such as when someone is jamming the remote base, you might not want the frequency to be spoken. In those cases, you can insert a '*' for a "megahertz point" while entering the frequency, like "142 147*38", and the controller will just say the *word* "Frequency" rather than telling you what the frequency is. If you want to reverse this logic, so the controller normally speaks the word "Frequency" and you have to enter a '*' to make the controller speak what the frequency is, use the last format in the table below.

<144> x	Select offset format x, don't change '*' readback setting
<144> x 0	Select offset format x, '*' disables frequency readback
<144> x 1	Select offset format x, '*' enables frequency readback

Parameters:

- 144 is the default command name.
- X is the new offset format. Used in conjunction with Command 143

Offset	X = 0	X = 1
0	Minus	Minus 20 (1200 only)
1	Plus	Minus
2	Simplex	Simplex
3	Minus 20 (1200 only)	Plus

Defaults:

- the default format is X = 0 and '*' makes it say the word "Frequency".

Note:

There is no command to recall which format you are using. If you are unsure, execute Command 143 1 D or unkey. If it says "plus", you are using format 0. If it says "minus", you are using format 1.

145: Set Power Level for RBI-1

This command allows you change the power of the radio connected to the Doug Hall RBI-1. The power level for the RLC-ICM is set with a jumper on the RLC-ICM and cannot be changed remotely without special wiring (connecting the control line to a open collector output on the controller).

<145> 0	Low Power
<145> 1	Medium Power
<145> 2	High Power

Parameters:

- 145 is the default command name.

Default:

- the default is low power

146: Set PL Frequency for RBI-1 or RLC-ICM

This command allows you change the PL (CTCSS) frequency of the radio connected to the Doug Hall RBI-1. The frequency you set will apply to both received and transmitted PL. See Commands 147 and 148 to turn the PL encoder and decoder on and off.

<146> x..x

Parameters:

- 146 is the default command name.
- X..X is the PL frequency in Hz. Valid frequencies are listed below. Default is 67.0 Hz.

Notes:

- The RLC-Club makes selecting PL frequencies easy by allowing you to enter approximate values for the PL frequencies. For example, you can select a PL of 71.9 Hz by entering any of the following values for X..X in the command above: 71, 72, 710, 719, 7100, and 7190. The RLC-Club takes the number that you enter and finds the closest match among the valid PL frequencies. When the synthesized voice responds to this command, it tells you the actual frequency selected, even if the value you entered was approximate.
- A '*' is never required as a decimal point, but can be used ("146 127*3") to tell the controller whether to speak the new PL frequency or whether to just say "PL". See command 144 for more information.

Valid RBI-1 PL Frequencies

67.0 Hz	85.4 Hz	103.5 Hz	127.3 Hz	156.7 Hz	192.8 Hz	241.8 Hz
71.9 Hz	88.5 Hz	107.2 Hz	131.8 Hz	162.2 Hz	203.5 Hz	250.3 Hz
74.4 Hz	91.5 Hz	110.9 Hz	136.5 Hz	167.9 Hz	210.7 Hz	
77.0 Hz	94.8 Hz	114.8 Hz	141.3 Hz	173.8 Hz	218.1 Hz	
79.7 Hz	97.4 Hz	118.8 Hz	146.2 Hz	179.9 Hz	225.7 Hz	
82.5 Hz	100.0 Hz	123.0 Hz	151.4 Hz	188.2 Hz	233.6 Hz	

Valid RLC-ICM PL Frequencies

33.0 Hz	54.9 Hz	82.5 Hz	114.8 Hz	159.8 Hz	189.9 Hz	233.6 Hz
35.4 Hz	56.8 Hz	85.4 Hz	118.8 Hz	162.2 Hz	192.8 Hz	241.8 Hz
36.6 Hz	58.8 Hz	88.5 Hz	123.0 Hz	165.5 Hz	196.6 Hz	250.3 Hz
37.9 Hz	63.0 Hz	91.5 Hz	127.3 Hz	167.9 Hz	199.5 Hz	254.1 Hz
39.6 Hz	67.0 Hz	94.8 Hz	131.8 Hz	171.3 Hz	203.5 Hz	
44.4 Hz	69.4 Hz	97.4 Hz	136.5 Hz	173.8 Hz	206.5 Hz	
47.5 Hz	71.9 Hz	100.0 Hz	141.3 Hz	177.3 Hz	210.7 Hz	
49.2 Hz	74.4 Hz	103.5 Hz	146.2 Hz	179.9 Hz	218.1 Hz	
51.2 Hz	77.0 Hz	107.2 Hz	151.4 Hz	183.5 Hz	225.7 Hz	
53.0 Hz	79.7 Hz	110.9 Hz	156.7 Hz	186.2 Hz	229.1 Hz	

147: Turn PL Encode Off/On for RBI-1 or RLC-ICM

This command allows you turn the PL (CTCSS) encoder of the radio connected to the Doug Hall RBI-1 off or on.

<147> 0	PL Encode Off
<147> 1	PL Encode On

Parameters:

- 147 is the default command name.

Default:

- the default PL encode off

148: Turn PL Decode Off/On for RBI-1 or RLC-ICM

This command allows you turn the PL (CTCSS) decoder of the radio connected to the Doug Hall RBI-1 off or on.

<148> 0	PL Decode Off
<148> 1	PL Decode On

Parameters:

- 148 is the default command name.

Default:

- the default PL decode off

149: Recall Band, Frequency & Offset for RBI-1 or RLC-ICM

This command allows you to recall the current band, frequency and offset settings of the radio connected to the Doug Hall RBI-1. The format of the voice response is given below. If you want information about power, PL, etc., see the next command: Command 150.

<149>

Parameters:

- 149 is the default command name.

Voice Response:

XXX.YYY The frequency in MHz. Determined by both the band (set with Command 141) and the frequency within the band (set with Command 142).

O The offset as indicated below:

"minus"	minus offset
"s"	simplex
"plus"	plus offset
"minus 20"	minus 20 MHz offset (1200 radios only)

150: Recall All RBI-1 or RLC-ICM Settings

This command allows you to recall all of the current settings for the RBI-1. The format of the voice response is given below.

<150>

Parameters:

- 150 is the default command name.

Voice Response:

XXX.YYY The frequency in MHz. Determined by both the band (set with Command 141) and the frequency within the band (set with Command 142).

O The offset as indicated below:

"minus"	minus offset
"s"	simplex
"plus"	plus offset
"minus 20"	minus 20 MHz offset (1200 radios only)

"power XXXX" power setting is low/moderate/high"

"PL XX.X Hertz" PL (CTCSS) frequency is XX.X hertz

"PL TX On/Off" PL encoder is on/off, "PL RX On/Off", PL decoder is on/off

151: Turn Radio Power On or Off for RBI-1

This command allows you to use the Doug Hall RBI-1 to turn the radio's power off, if the radio supports it. It does not work with the RLC-ICM, only with the Doug Hall RBI-1.

<151> 0	Radio Power Off
<151> 1	Radio Power On

Parameters:

- 151 is the default command name.

Example:

I want to turn off the power on my 2 meter radio

<151> 0

Voice Response:

"Radio Power <ON/OFF>"

152: Goto Radio Memory Channel for the RBI-1

This command allows you to go to one of the memory channels that is stored on the radio. These memories must be set up ahead of time, since there is no way to program them using the RBI-1. The controller doesn't know what frequency (or any of the other settings) the memory has in it - that is determined totally by the radio. Only some radios support this feature. The most common use for memories is to go to frequencies that you can't get to otherwise, such as NOAA weather frequency. If you have more than one radio connected to the RBI-1, the memory recall command always goes to the last radio you sent a frequency to. So if you are on two meters and you want to recall a memory on the 220 radio, you need to enter a 220 frequency first to select that radio, then use this command to goto the memory. The number of memories available is determined by the radio. This command does not work on the RLC-ICM, as those band modules do not have internal memories. It is possible to program macros on the controller that go to a specific frequency, offset, etc and use them like memories.

```
<152> x..x
```

Parameters:

- 152 is the default command name.
- x..x is the memory to go to (1..20, or as supported by the radio)

Notes:

When you recall a memory and follow that with a 'Recall all RBI-1 settings (Command 150)' only the radio power and memory information will be recalled. Because the memory contents are not known by the controller, the frequency readback can not be used. It is a good idea to have the frequencies noted for future use.

Example:

I want to recall the NOAA weather channel which is in memory channel 15.

```
<152> 15
```

Voice Response:

"Look Up <x..x>"

Chapter 15: Serial Controlled (HF) Radio Support

This section describes the controller's interface for serial controlled radios. Most such radios are for the HF bands, but some such as the FT-736 handle the VHF and UHF bands. The controller's software will handle frequencies through the 1.2GHz band for radios that support them. When "HF radios" are referred to in this chapter, other serial controlled radios are also included.

HF Radio Interfacing

The audio in, audio out and PTT connections to the serial controlled radio should be made just like for a repeater or any other radio, as described in Chapter 1. If the serial controlled radio has a COR output (from an all-mode squelch), it can be connected normally as well. If the radio does not have a COR output, set the COR polarity for that radio port to active high, so the internal pullup will make it always active (or leave it active low and tie the COR input to ground). This is necessary because the controller normally mutes incoming audio unless the COR line is active (see command 005 for more information). Note that having the COR line always active will make the HF receiver timer out, so you might want to disable the time out timer for that radio port by setting it to zero (with command 020). If it does time out, you can reset the time out timer by resetting the controller with command 035 (you will have to exit HF mode to do that).

In addition to the audio in, audio out, COR and PTT signals, you will need to connect the controller to the radio's serial port, so you can control the frequency and other settings. Before doing this, execute command 195 so the controller will know not to echo serial characters to the radio (which can cause then to get into an endless loop). Most serial controlled radios use TTL level signals, rather than the RS-232 signals that computers, mice, modems, and the controller's main serial port all use. RS-232 signals switch between +12 and -12 volts, while TTL signals change from 0 to 5 volts. A few radios use RS-232 level signals. **Do not connect an RS-232 serial port to a TTL serial port without an adapter!** Adapters to convert TTL signals to RS-232 signals can be purchased from the radio manufacturers or built from scratch. Some of these adapters may invert the data (the Kenwood TS-870 for example), just to make it more confusing. We have schematics for the level converters for some radios; check our web page or call us for more information. Once you have connected an adapter to the radio, you can simply connect the RS-232 serial port on the adapter to main serial port on the RLC-Club. This is the same serial port you can use to connect the RLC-Club to a computer, so you can only use one at a time: either the HF radio or the computer for control.

If you are using a Kenwood level translator, you may have to connect pins 4 and 5 together on the DB-25 connector that plugs into the level translator. This connects the RTS and CTS handshaking lines.

If want to use TTL level output, take a 16 pin socket and solder a jumper wire between pins 11 and 14 on the top of the socket. Remove the Max232 and plug in the socket instead (don't plug the Max232 into the socket). It will hook the processor's TTL output up to the data out line on the DB-9 without doing a level conversion like the Max232 does. Please note that hooking up the TTL output directly bypasses the protection of the Max232 and exposes the processor to the outside world. Shorting out the TTL output line or hitting it with static may damage the processor,



requiring that it be sent back to Link Communications for repair (the processors are not easy to replace in the field, and if you damage the socket trying, there are 132 little pins to try to desolder to replace it). Use the TTL output at your own risk; getting a level translator from the radio manufacturer is much safer.

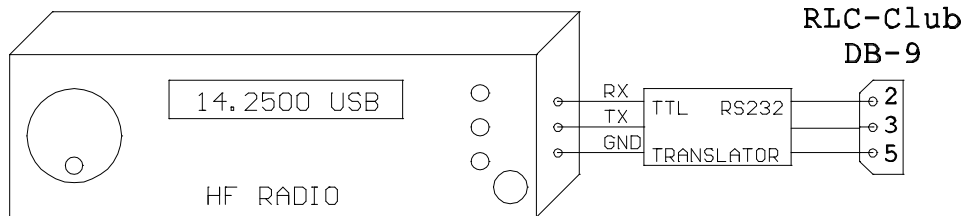

HF Radio Control:

There are several commands that are used to set up the HF radio interface. They tell the controller what radio is installed and a few other things. After the radio is set up and you are ready to change frequencies, scan, etc., you can go into a special "HF control mode". When you are in this mode, all of the normal commands are disabled and a separate set of HF control commands are used instead. This makes it possible to control the HF radio with short command codes without having to worry about what other commands might get executed accidentally. These commands are organized by mapping the DTMF keypad in a logical way that makes the various commands easy to remember. When you are done using the HF radio, there is a command code that takes you back to the normal mode where you can execute the normal commands. It is possible to execute HF commands from normal mode using command 199. This is usually used in a macro. There is also a way to execute normal commands while you are in HF mode (see keypad code 4). And finally, there are event triggers (see command 157) that are called when the different HF commands are entered that can be used to customize how the HF commands work (not finished yet). While in HF mode, the '#' key is used as the force-execution digit to make it easier to control the HF remote from the reverse autopatch.

Virtual Radio Features:

Although the RLC-Club's HF remote base interface is loaded with features, it uses only the most basic features on the HF radio itself: receive frequency, transmit frequency, vfo, split, and mode. The rest of the features are provided by the RLC-Club itself. This allows the RLC-Club to provide all of those features even on radios that don't have built-in support for them. Scanning is performed by sending a change of frequency several times a second, so the controller always knows what frequency the radio is on and so it can handle scan edges even if the radio doesn't support them directly. Memories are stored on the controller, so radios without built-in memories can support them with the RLC-Club. Even VFO A and VFO B are simulated by the controller; they work like you would expect but both use VFO A on the radio (the radio's VFO B is used to handle offsets with some radios). You could call all of these features that are handled by the controller "virtual" features, since they may or may not exist on the radio but the controller makes it work like they do.

The only reason you need to know about which features are virtual and which ones actually use the features of the radio is so you can understand why the display on the radio doesn't always reflect the commands you enter. Watching the display on the radio may be more confusing than just using the frequency recall command (keypad command '8') while you are in HF mode.

Default Values:

The first time the HF remote is turned on (or after it has been reinitialized), it will go to 14.25 Mhz, USB. All of the virtual memories also default to 14.25 Mhz, USB. Of course you can change them to any other frequency you may choose.

Example:

I want to control a Kenwood TS-870S. I want my command prefix digit to be '1', so I enter "195 11". I then enter "196 2 2 0" to set the radio type and tell the controller that it will be connected to port.two. The audio cable is built just like the one for my repeater was. Since the TS-870S already has a RS-232 serial port, I don't need a level converter, but I do need a null modem adapter in the serial cable between it and the controller to connect the data out line on each end to the data in line on the other. At least for now, I don't care about transmit or scan band edges, so I am going to skip command 197. Entering "198" from the repeater on port 1 turns on HF mode and sets the frequency to 14.25 Mhz. "179" starts it scanning up fast. Kerchunking it stops the scan. "13" will turn of HF mode.

195: Configure HF Mode

This command configures the HF control mode and assigns the HF command prefix digit. It also tells the RLC-Club that the serial port will be used for HF control rather than for programming the controller. You must disable HF control before the serial port will work for programming again.

<195> 0	Disable HF
<195> 1 p	Enable HF and set HF prefix digit to 'p'
<195> 2	Turn HF off without enabling or disabling
<195> 3	Recall HF mode settings

Parameters:

p = the HF command prefix digit. This is the digit that must be pressed before any command is entered in HF mode. It is commonly set to '1'. If you prefer not to use a prefix digit, just enter "195 1".

Notes:

- When you disable HF with "195 0", the HF remote will be turned off if it is in use and it will be disabled so it cannot be turned back on until it is enabled with this command.
- Normally the HF remote will be turned off from the port that is using it, by entering the HF command prefix digit followed by a '3' (the exit command - see the HF commands on the following pages). If you need to turn the HF remote off from another port (one that is not currently controlling the HF remote), you can enter "195 2".

Voice Response:

"HF on/off, key x" where "on/off" indicates whether HF is enabled or disabled (not whether HF mode is turned on or not) and "x" is the HF command prefix digit. "x" will be "clear" if no prefix digit is used.

Example:

I want the remote base turned on and I want my HF command prefix digit to be a '1'.

195 1 1

196: Configure HF Radio

This command tells the controller which radio port the HF radio is interfaced to and which type of radio it is. The controller uses this information to automatically set the baud rate (4800 for Kenwood or Yaesu, 1200 for Icom) and to send the proper command codes for your radio.

<196> 0	Recall HF Radio Configuration
---------	-------------------------------

<196> p 2 0	Kenwood TS-450, TS-570, TS-690, TS-850, TS-870, TS-950 and other recent radios
<196> p 2 1	Kenwood TS-50, TS-140S, TS-440, TS-440S, TS-680, TS-711, TS-790A, TS-811, TS-940, R-5000 and other early radios

<196> p 3 0	Yaesu FT-736
<196> p 3 1	Yaesu FT-757 (no control of modes), FT757GXII
<196> p 3 2	Yaesu FT-767
<196> p 3 3	Yaesu FT-747GX, FT-890, FT-900, FT-990, FT-1000
Not Supported	FT-727R, FRG-8800

<196> p 1 xx	Icom. See table on next page or check your radio manual to find 'xx' (the address) for your radio
--------------	---

Parameters:

p = the radio port that the HF radio is connected to.
xx = radio address (Icom only)

Normally if you are transmitting on the HF radio and you enter a command that causes serial data to be sent to the radio, such as changing a frequency, the controller will automatically drop the PTT to the HF radio while the serial data is sent. Some radios like the Yaesu FT-736 and the Kenwood TS-711 require this. Even radios that don't require it seem to have less problems with getting incorrect commands if they are not transmitting while they receive data, probably due to RF getting into the serial cable. If you want the controller to keep transmitting while it sends serial data, append a '1' to the end of the appropriate command above. For example: "196 2 2 1 1" would select port 2, Kenwood, type 1, leave PTT on when sending serial. "196 2 2 1" would make the PTT drop while sending serial.

Voice Response:

"HF on <port>, <I/K/Y><type> On/Off" where <port> is the radio port on the controller that the HF radio is connected to, <I/K/Y> signifies the brand of the radio (Icom, Kenwood or Yaesu, respectively), and <type> signifies the radio type. On/Off indicates whether the PTT will be left on while serial data is being sent (default is off).

Icom Notes:

- Because the Icom radios can co-exist on a common serial bus (CI-V), a radio address is needed to select what radio gets the serial data. The list below shows the addresses of some Icom radios. If you don't find your radio listed, check your radio's owner's manual.
- Some Icom radios will let you change their addresses. This should not cause any problems as long as you don't change the address of an IC-735 to anything but 04 and you don't change the address of any other radio to 04. The IC-735 uses a slightly different format to set the frequency and the controller software uses this format whenever the radio address is set to 04.

Icom Radio Addresses

Radio Address	Radio Type	Radio Address	Radio Type
04	IC-735	34	IC-471 A/E/H
08	IC-R7000	36	IC-1271 A/E
16	IC-275 A/E/H	38	IC-781
18	IC-375 A	40	IC-725
20	IC-475 A/E/H	42	IC-R9000
22	IC-575 A/H	44	IC-765
24	IC-1275 A/E	46	IC-970 A/E/H
26	IC-R71 A/E/D	48	IC-726
28	IC-751 A	50	IC-R72
30	IC-761	52	IC-R7100
32	IC-271 A/E/H	Other ...

Example 1:

I want to tell the controller that there is an Icom IC-725 on radio port 2.

195 2 1 16



197: Set/Recall Transmit/Scan Band Edges

This command allows you to set and recall the edges of the frequency ranges that you are allowed to transmit in and within which the scanning function will loop. These two features are completely separate: they are stored separately and they operate independently, although the frequency ranges for both are set with this command.

Transmit Edges: The controller will let you receive on any frequency, but only transmit within the transmit edges that you set up with this command. This protects you from accidentally transmitting on a frequency you shouldn't.

Scan Edges: The controller will let you start scanning from any frequency. Since you will often want to focus on a small frequency range, it will also allow you set a more limited range to scan within. This is the purpose of the scan band edges. Even if you started scanning from a frequency that was not within any of the scan bands, if you are scanning up and reach the top edge of a scan band, it will automatically loop to the bottom edge and continue scanning. If it reaches the bottom edge of a scan band, it will automatically loop to the top edge. It will speak the current frequency immediately before and after looping.

197 e	Recall Edges for all Bands
197 e c	Set Edges for all Bands for a Class (novice..amateur extra)
197 e bb	Recall Edges for one Band
197 e bb c	Set Edges for one Band for a Class
197 e bb u f..f*f..f	Set Upper or Lower Edge for one Band to a Specific Frequency

Parameters:

e = 0 to set a transmit band edge(s), 1 for a scan band edge(s)

c = Class to set edge(s) to. You can find out what the edges are for each class by setting them then recalling them with this command.

0	Novice
1	Technician / Tech Plus
2	General
3	Advanced
4	Amateur Extra

bb = 0..15 which band. See the table below. You don't have to leave the bands as they default if you want to re-assign them some other way. If two bands overlap, the first one found that contains the current frequency will be used.

u = 0 for lower edge, 1 for upper edge. If you try to set the upper edge to a lower frequency than the lower edge, the lower edge will be set to match it. If you try to set the lower edge to a higher frequency than the upper edge, the upper edge will be set to match it.

f..f*f.f = the new frequency. The '*' should go between the 1MHz digit and the 100KHz digit of the frequency. Example "14*25" for 14.25MHz. Frequencies over 2GHz have not been tested.

Defaults:

The following table shows the defaults for both the transmit and scan edges (they can be set separately). These are the edges of the voice bands for the amateur extra class. Note that voice is not allowed on 30 meters. There is also a user defined band at the end that you can set for any other frequency range.

Band	bb	Lower Edge	Upper Edge
160 meters	00	1.8 Mhz	2.0 Mhz
80 meters	01	3.75 Mhz	4.0 Mhz
40 meters	02	7.15 Mhz	7.3 Mhz
30 meters	03	0.0 Mhz	0.0 Mhz
20 meters	04	14.15 Mhz	14.35 Mhz
17 meters	05	18.11 Mhz	18.168 Mhz
15 meters	06	21.2 Mhz	21.45 Mhz
12 meters	07	24.93 Mhz	24.99 Mhz
10 meters	08	28.3 Mhz	29.7 Mhz
6 meters	09	50.1 Mhz	54.0 Mhz
2 meters	10	144.1 Mhz	148 Mhz
1.25 meters	11	222.0 Mhz	225.0 Mhz
70 cm	12	420.0 Mhz	450.0 Mhz
33 cm	13	902.0 Mhz	928.0 Mhz
23 cm	14	1240.0 Mhz	1300.0 Mhz
user defined	15	0.0 Mhz	0.0 Mhz

198: HF Mode Enable

This command enables the HF remote base mode. This mode re-defines the DTMF keyboard into a quick HF remote access pad. When this mode is enabled, only HF commands can be entered (see the following pages). In order to execute any system wide commands the user must get out of the HF mode with keypad command '3' or use keypad command '4'.

<198>

Parameters:

There are no parameters for this command

Defaults:

HF mode is disabled

Response:

- "HF Remote On <frequency>" if successful.
- "HF is off" if need to enable HF control with command 195.
- "HF busy X" if another port is in HF control mode. X is the number of the port this is currently using the HF remote. If they just forgot to exit HF mode, you can turn them off with "195 2", then enter "198" again to enable control from the port you are using.
- "Error 217" if you are already in HF mode.

HF Prefix:

The HF prefix is a single digit that is configured with Command 195. This digit is always the first digit entered when executing a command while in HF mode. The reason for the prefix digit is to keep single digit entries from accidentally being entered.

Example: I am in HF mode and need to start the scan function for fast up scanning

Enter: 1 79 unkey or '#' Response: "Scan up fast"

Example: I am in HF mode and need to enter a frequency

Enter: 1 29*600 unkey or '#' Response: '2 9 point 6 0 0 0 0'

Example: I am in HF mode and need to recall memory 15

Enter: 1 515 unkey or '#' Response: <frequency>

In all these examples the format for data entry was:

<HF Prefix> <Command> <Additional Data if Needed> <unkey or '#>

HF Remote Base Keypad Definition:

1: RX Only 1x: HF Mode... 1 - USB 2 - LSB 3 - AM 4 - FM 5 - CW	2: RX and TX 21: Toggle PL RX 22: Toggle PL TX 23: PL Off 28: Recall PL 2<Hz>: Set PL Freq	3: Exit HF Mode, Return to Normal Command Mode	A: Bump Up 20Hz
4: Bump Down 100Hz 4<name>: Execute Command by Name	5: Select VFO A 5xx: Recall Memory 0..99	6: Bump Up 100Hz	B: Bump Down 20Hz
7: Bump Down 500 Hz 7x: Start Scan... 1 - Down Slow 3 - Up Slow 4 - Down Med. 6 - Up Medium 7 - Down Fast 9 - Up Fast	8: Recall Current VFO Settings 80: Offset Off 81: Offset On 811: Minus Offset 810: Plus Offset 81xy: Set size of offset for this band	9: Bump Up 500Hz	C: Not Defined
* Use as Frequency <Point> Key	0: Select VFO B 0xx: Write Memory Channel 0..99	#: Force- Execution Digit, Like an Enter Key	D: Not Defined

Explanation of Keypad Commands:

Remember that before pressing the digit shown on the keypad map above, you must enter the HF prefix digit you set with command 195. The prefix digit is shown as a 'p' in the descriptions below; it defaults to '1'.

Digit 1:

- "p 1": Selects receive only mode. Keying the repeater will not cause the HF radio to transmit while in receive only mode. You can also go to any frequency the radio supports while in this mode, while the allowed frequency ranges may be restricted when transmit is enabled. Voice response: "HF Receive". This does the same thing as command 001 does when you are not in HF mode.

- **"p 1 x"**: Select radio mode. "x" is from the table below. If your radio supports wide and narrow versions of a mode, the wide version will be used.

"x"	Definition
1	Selects USB Mode
2	Selects LSB Mode
3	Selects AM Mode
4	Selects FM Mode
5	Selects CW Mode

Digit 2:

- **"p 2"**: Select transceive mode. Keying the repeater will cause the HF radio to transmit while in this mode. You can only go to frequencies that are within the transmit band edges while in this mode. If you try to go to a disallowed frequency, or if you try to enable this mode while on a disallowed frequency, the controller will generate the HF error (the default is for it to speak "error 217") and will not do it. If this command is successful, you should hear the voice response: "HF Transmit". This does the same thing as command 000 does when you are not in HF mode.
- **"p 2 1"**: Toggle PL receive requirement. Normally off. If turned on, receiver squelch will not open unless the correct PL frequency is detected. Not supported by all radios. On the Yaesu FT-736, PL receive only works when PL transmit is enabled.
- **"p 2 2"**: Toggle PL transmit setting. Normally off. If turned on, will transmit the current PL frequency. Not supported by all radios.
- **"p 2 3"**: Turn PL receive and transmit off.
- **"p 2 8"**: Recall PL receive and transmit settings and frequency.
- **"p 2 <Hz>"**: Set the current PL frequency to <Hz>. Do not use the '*' as a decimal point. You can enter the frequency to the nearest Hz, and the controller will look it up the nearest exact match for you.

Digit 3:

- **"p 3"**: Exit HF mode and return to normal command mode. Voice response is "HF Off".

Digit 4:

- **"p 4"**: Bump down 100 Hz. If you are in transceive mode, you may get an error if the new frequency would be disallowed by the transmit edges. Voice response is "Down 100".
- **"p 4 <command name>"**: Execute command <command name>. For example: "p 4 026" would recall the time from HF mode, just as "026" would from normal command mode.

Digit 5:

- **"p 5"**: Selects virtual VFO A. Has no effect if you are already using virtual VFO A. Restores the receive frequency, transmit frequency offset and mode to whatever they were

when you last used virtual VFO A.

- "**p 5 x**" or "**p 5 xx**": Recalls the contents of virtual memory "xx" into the current virtual VFO. This includes the receive frequency, transmit frequency offset and mode. Once a memory has been recalled, you can bump up or down, scan, or do anything else you would do with a frequency you entered directly into the VFO. Since the memories are virtual, that is they are stored in the controller's memory rather than in the radio, all 100 memories will work regardless of whether your HF radio has built-in memories or not.

Digit 6:

- "**p 6**": Bump up 100 Hz. If you are in transceive mode, you may get an error if the new frequency would be disallowed by the transmit edges. Voice response is "Up 100".

Digit 7:

- "**p 7**": Bump down 500 Hz. If you are in transceive mode, you may get an error if the new frequency would be disallowed by the transmit edges. Voice response is "Down 500".
- "**p 7 x**": Start scan type "x" (see table below). Scanning is normally stopped by keying up. If you are using command 199 to control the HF radio, you may find it useful to enter a value for "x" that is not in the table below to stop scanning.

"x"	Definition
1	Scan Down Slow
3	Scan Up Slow
4	Scan Down Medium
6	Scan Up Medium
7	Scan Down Fast
9	Scan Up Fast

Digit 8:

- "**p 8**": Recalls the current frequency, offset (if not zero) and virtual VFO (if it is VFO B).
- "**p 8 0**": Turn transmitter frequency offset off (set it to 0). Voice response is "Off".
- "**p 8 1**": Turn transmitter frequency offset on (set it to whatever offset was last used on this band). Voice response is "<offset frequency> Mhz". The controller will not bother to tell the radio to go into split mode unless you have transmit enabled (keypad command 2).
- "**p 8 1 x**": Turn offset on and make it negative if "x" is 1, positive if x is 0 or 2.
- "**p 8 1 x y**": Turn offset on and make it negative if "x" is 1, positive if x is 0 or 2. Set offset size "y" from the table below.

Offset Code	Offset size
0	0
1	100 Khz
2	500 Khz
3	600 Khz
4	1 Mhz
5	1.6 Mhz
6	1.7 Mhz
7	5 Mhz
8	12 Mhz
9	20 Mhz

Note: Only some Icom radios support controlling the split function from the serial port. Those that do include the IC-725, IC-726, IC-765, IC-781, and IC-970. The IC-R71, IC-R72, IC-271, IC-275, IC-375A, IC-475, IC-735, IC-471, IC-575, IC-751, IC-751A, IC-761, IC-1271, IC-1275, IC-R7000, IC-R7100, and IC-R9000 do not support turning split on and off from their CI-V interfaces. If you attempt to turn split mode on for a radio that doesn't support it, the controller will send the command and respond as if it worked, but the radio will not change. If you want to control split mode remotely, you can wire one of the controller's output lines to the split button on the radio. Then you will be able to "push" the split button by turning the output line on and off.

Digit 9:

- "p 9": Bump up 500 Hz. If you are in transceive mode, you may get an error if the new frequency would be disallowed by the transmit edges. Voice response is "Up 500".

Digit 0:

- "p 0": Selects virtual VFO B. Has no effect if you are already using virtual VFO B. Restores the receive frequency, transmit frequency offset and mode to whatever they were when you last used virtual VFO B. VFO B is called a "virtual VFO" because the controller keeps track of it separately from virtual VFO A so it will work as you would expect, but both will usually use VFO A on the radio. In other words, if you look at the radio, it will probably show VFO A even when you select virtual VFO B.
- "p 0 x" or "p 0 xx": Writes the contents of the current virtual VFO into virtual memory "xx". This includes the receive frequency, transmit frequency offset and mode. Since the memories are virtual, that is they are stored in the controller's memory rather than in the radio, all 100 memories will work regardless of whether your HF radio has built-in memories or not. Voice response is "Write xx".

Digit A:

- **"p A"**: Bump up 20 Hz. If you are in transceive mode, you may get an error if the new before the 100 Khz digit. Voice response is "Up 20".

Digit B:

- **"p B"**: Bump down 20 Hz. If you are in transceive mode, you may get an error if the new before the 100 Khz digit. Voice response is "Down 20".

Digit C and D: Not used.

Digit *: Used only when entering frequencies. See the instructions for "HF Frequency Entry:" below.

Digit #': Used to make a command execute right away, without waiting for you to unkey. Similar to the forced execution digit of 'D' that is used when not in HF mode. If you press '#' after entering a command, you may not be able to hear part of the voice response to that command. Simply unkeying will avoid this problem.

Scanning:

Although your HF radio may have a scan feature built in, it is not used when scanning with the controller (see the "Virtual Radio Features" section at the beginning of this chapter). Instead, the controller sends a new frequency to the radio several times a second. Each time a new frequency is sent, it is 20, 100 or 500Hz different than the previous frequency, depending on whether you have selected slow, medium or fast scanning. A new frequency is sent just as often when scanning slowly as when scanning fast, but because the frequency is changed by a different amount, the resulting scan rate is different. You can change how often a new frequency is sent to the radio by adjusting a timer. Changing that timer will affect all three scan rates. See command 020 in Chapter 4 for information about changing the HF scan timer value.

When the controller reaches the top or bottom of a scan band (see command 197), it will speak the current frequency, wrap around to the other edge of that band, speak the frequency again, and continue scanning. It will also speak the frequency every 10 Khz when scanning slow or medium or every 25 Khz when scanning fast.

HF Frequency Entry:

To enter a new frequency, press the HF prefix digit (default is '1') followed by the frequency. Put a '*' after the 1 Mhz digit. For example, to go to 14.25 Mhz, enter "1 14*25" and unkey or press '#'. Leading and trailing zeros are optional. The '*' must be entered, as that is the only thing the controller uses to tell whether you are entering a frequency or another command.

Automatic Mode Selection:

When frequencies below 10 Mhz are entered, LSB mode is automatically selected. When frequencies between 10 Mhz and 29 Mhz are entered, USB mode is automatically selected. When frequencies above 29 Mhz are entered, FM mode is automatically selected. Of course you can always override the default mode (using keypad command 1). When memories are recalled, they retain the mode they were stored with, rather than using the automatic mode selection feature.

Typical HF remote base session:

HF Prefix is '1'

- 1) 106 D or unkey ; Enable HF remote mode
- 2) 1 29*68 # or unkey ; Move the HF remote to 29.680 mhz, VFO 'A'
- 3) 1 0 # or unkey ; Select VFO 'B'
- 4) 1 29*58 # or unkey ; Move the HF remote to 29.580 mhz, VFO 'B'
- 5) 1 5 # or unkey ; Select VFO 'A'
- 6) 1 8 1 # or unkey ; Select Split (Repeater Mode)
- 7) 1 2 # or unkey ; Go into transmit and receive mode
- ...
- 1 3 # or unkey ; Cancel HF mode after communications are complete

199: Enter HF Command (w/o being in HF mode)

This command allows you to control an HF radio without switching into HF mode with command 198. This may be useful when you just want to change just one thing or if you want to write a macro that will do a lot of things at once. After entering the command name, you should enter your HF prefix digit (if you have one, see command 195, then any other digits you would enter if you were in HF mode (1 for receive, 14*25 to change frequency, etc).

199 p h..h

Parameters:

- p = your HF command prefix digit if you have one (see command 195)
- h..h is a command you would normally enter while in HF mode (they are described after command 198)

Notes:

- It is possible to write a macro that uses command 199 to do several things, then execute that macro from HF mode using the keypad digit 4.

Chapter 16: Special Audio Routing Commands

See Appendix A for more information about audio routing.

037: Set Audio Routing Variable for Commands In a Macro

This command allows you to override the default message routing variable within a macro. It only remains in effect until the end of the macro or until 037 or 038 are executed, whichever comes first. Appendix A has more information about controlling where messages are sent. The most common use of this command is to send the audio generated by commands in a macro to a different combination of ports than it is normally sent to. An example of this is provided below.

```
<037> p..p
```

Parameters:

- 037 is the default command name.
- P..P is the list of ports the message is to be routed to.

Note:

The changes made to the audio routing variable by this command affect all commands (including other macros) executed until the end of the macro containing this command, or until command 037 or 038 are executed again, whichever occurs first.

Example:

You have repeaters on ports 1 and 2. You want to make a recall time command that will speak the time out of all the repeaters whenever it is executed. Since command responses normally only go out of the port that entered the DTMF command, we need to use a macro and manually change the audio routing variable (with 037). We will use the command to recall the time in the male voice (026) for this example. You could use any of the user macros (300..499), but we will use 400 for this example.

- First we will recall macro 400 to make sure that there is nothing stored in it that we want to keep:
054 400 D or unkey or <Enter>
- If it has something in it, we can delete it with 055 400 D or unkey, or choose a different macro.
- Now we can append the commands we want to the macro. The first command we want the macro to execute will set the audio routing variable to ports 1 and 2. This command is 037 124 D or unkey. To append it onto the end of the macro we enter 056 400 037 12 D or unkey.
- We then want the macro to recall the time (command 026). To append this onto the end of the macro we enter 056 400 026 D or unkey.
- Now we can cause the time to be recalled out ports 1 and 2 by executing the macro 400.
- If you want to rename this macro to "567", for example, do the following: 010 400 567 D or unkey. Now entering 567 and unkeying will execute the macro and cause the time to be spoken out ports 1 and 2.

038: Kill All Responses Following This Command

This command kills all voice/CW responses beyond this point. This command designed for use within a macro. When multiple commands are executed inside a macro, the commands that are executed contain their own message responses. To keep from hearing all of the responses when the macro is executed, simply execute command 038 first, then all messages following that command are canceled. If you want a message response to occur from within a macro, speak the response before you execute 038.

<038>

Parameters:

- 038 is the default command name.

Notes:

The changes made to the audio routing variable by this command affect all commands (including other macros) executed until the end of the macro containing this command, or until command 037 or 038 are executed again, whichever occurs first.

Example:

Want to read the change the access mode of port 1 and speak a message indicating what you did.

1) Use a multiple command macro for this purpose

Command 400 will be used to execute this sequence (Macro 400)

2) 005 is the Access mode change command

Want to change the mode to COR and PL Access

005 1 2 "Port 1 COR and PL"

3) 036 is the Voice message speak command

Want to speak "Repeater on PL"

4) Macro programming:

055 400 ;

erase the macro

056 400 036 267 229 046 042 ;

speak "Repeater on PL"

056 400 038 ;

be quiet for rest of macro

056 400 005 1 2 ;

set to PL access mode

5) The macro will speak the message "Repeater On P L" and not the mode change message "1 2"

065: Restore Audio Routing Variable (Undo 037 and 038)

This command allows you to restore the audio routing within a macro to whatever it was at the beginning of the macro. In other words, if commands 037 or 038 have been executed earlier in the macro, their effects will be negated. It has no effect if used outside of a macro.

<065>

Example:

I want to make a macro to connect ports 1 and 2 and speak "Link Up" to whichever port entered the command (which is the default, see command 050). This can be done without using command 065 as follows:

055 500 ;	erase whatever is in macro 500
056 500 036 292 507 ;	speak "link up"
056 500 038 ;	be quiet for the rest of this macro
056 500 000 12 ;	connect ports 1 and 2

The above method may seem backwards, as the command to send the "link up" response comes before the ports are actually connected. When the controller executes the macro, it puts the words "link up" in a buffer to be spoken when the voice synthesizer has time and immediately goes ahead and finishes the macro, connecting the ports. Assuming that the voice synthesizer is not busy speaking something else, it will speak "link up" soon afterward.

The following macro does the exact same thing, and will sound exactly the same to the person that enters it:

055 500 ;	erase whatever is in macro 500
056 500 038 ;	be quiet for the rest of this macro, unless command 037 or 065 are executed
056 500 000 12 ;	connect ports 1 and 2
056 500 065 ;	set the audio routing back to what it was at the beginning of this macro
056 500 036 292 507 ;	speak "link up"

Note that the ports are connected first, then the audio routing is restored and the message is sent. It takes one more command in the macro (065) to put things in this order, but if it makes more sense to you do program your macros this way, there is no harm in doing it. Note that in both macros, command 038 is needed to keep the default response of command 000 from being spoken: "one connect two".

039: Recall the Ports in the Current Audio Routing Variable

This command allows you to determine what ports audio is being sent out of without having a radio tuned to each of the transmitters. It speaks a list of numbers which represent the ports that are included in the audio routing variable at the time it is executed (see Appendix A for more information about audio routing variables). If it is executed directly, it will tell you what port you are executing commands from..

```
<039>
```

Example:

You want to know what transmitters are hearing the courtesy beep that is generated when port 2's receiver unkeys. Solution: append this command to the end of the courtesy beep macro (233) for port 2 so it will speak the number of the ports that just heard the courtesy beep:

```
<056> 233 039 D or unkey or <Enter>
```

Note:

To delete command 039 from the courtesy beep macro when you are tired of hearing it, use command 058 and you will not have to delete the whole macro and program it again.

050: Set Up or Recall Default Audio Routing Variables

This command allows you to configure which transmitters send different voice messages and tones. Each time a command is executed that generates a message to tell you what it did or an event occurs that triggers a message, the controller figures out what transmitters should send that message and stores it in an "audio routing variable" until it is actually sent. Normally if you enter a command using DTMF on a repeater, the response message will be sent out that repeater so you can hear it. The same goes for a link. But in some cases, you might want the response messages to commands entered from a link to be sent out both the link and a repeater, so you can keep track of what is going on. This command allows you to do that. It allows you to control where response messages will be sent for commands that are entered from each receiver or the serial port. It also allows you to control where messages that are generated by the scheduler, I/O alarms and event triggers will be sent.

Please note that when a macro is executed, it may override these default settings by using commands 037 and 038 (they only work inside of a macro). This command sets the *default* routing; commands 037 and 038 override it and change it to something else. If it has been changed using commands 037 or 038 in a macro, command 065 will restore it to the default setting for the remainder of the macro.

Recall Default	<050> SS
Set Default to P..P	<050> SS P..P
Clear Default	<050> SS 0

Parameters:

- 050 is the default command name.
- SS specifies which default audio routing variable to change
 - 01 - commands entered from receiver 1
 - 02 - commands entered from receiver 2
 - 03 - commands entered from the autopatch
 - 04 - commands entered from the serial port
 - 05 - commands executed by an event trigger or automatic macro
 - 06 - commands executed by the scheduler
 - 07 - commands executed by an I/O alarm
- P is a list of the ports that the audio will be sent out of. Enter a '0' if you do not want the audio to be sent anywhere.

Default:

Commands entered from a receiver are sent to whichever port entered the command. All others default to sending messages out transmitter 1.

Notes:

- When you enter a command on the serial port to change the audio routing variable for commands entered from the serial port, the routing is changed before the response to this command is generated. For example, if you turn the responses off by entering "050 0", you won't get a voice response. If you enter "050 0 1" to turn them back on for port 1 (the default), you will get a voice response out port 1.
- Command 114 (the autopatch hangup command) can not be controlled with this command, as it sets its own audio routing to speak the hang up message to all of the ports that are listening to the patch, not just to the one that hung it up.
- See Appendix A for more information about audio routing variables in general, commands 037, 038 and 065 for information about routing audio within a macro.



Chapter 17: Special Control Commands



035: Remotely Reset the Controller

This command allows you to remotely reset the RLC-Club controller. This does exactly the same thing as turning the power off and back on or pressing the reset switch on the board. It will not cause you to lose any of your programming - that is only possible by being at the site of the controller and following one of the initialization procedures described in Appendix D.

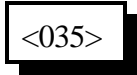
A small icon of a terminal window with a black border and a white background, containing the text "<035>".

<035>

Parameters:

- 035 is the default command name.



078: Set Command Entry Options for a Port

This command allows you to specify several options concerning how the controller will process the characters you enter.

```
<078> p c t e
```

Parameters:

- 078 is the default command name.
- P is the port for which to change the options
 - 1..3 indicate the corresponding port (3 is the autopatch)
 - 4 indicates the serial port
- C is the chaining control. This variable allows your commands to be chained together. Must be entered but is ignored for the serial port.
 - 1 Enables command chaining
 - 0 Disables command chaining (the default)
- T is the timed execution. This variable allows timed execution of commands entered. Must be entered but is ignored for the serial port.
 - 1 Enables timed execution
 - 0 Disables timed execution (the default)
- E (optional) is the new force-execution digit (default is 'D' for radio ports, '!' for the serial port).

Command Chaining:

Normally the controller considers everything you enter before unkeying or pressing 'D' or the enter key to be one command. If there are more characters that it knows what to do with, it generates an error message and discards the command. The chaining option lets you enter more than one command at a time, executing all of them at once when you unkey. This can cause problems when it is ambiguous where one command ends and the next begins, but may be useful in some cases.

With the chaining option turned on, the controller will let you chain on another command without unkeying after any command that always takes the same number of digits. This includes all of the macros and a lot of the commands numbered 000 to 199 (those which never take any digits after the command name). Of the remaining commands numbered between 000 and 199, you can find out which commands can have another command come immediately after them by looking them up with command 011; if it does not say "variable", you can enter another command after it. If command 011 does say "variable", that command must be the only command entered or the last command in a chain of commands. It is recommended that you leave this option turned off unless you have a specific reason to turn it on. This option is not available (the setting is ignored) for commands entered from the serial port.

Timed Execution:

Normally when you enter a DTMF command, you unkey to tell the controller it is time to execute the command. If you enter a command and wait longer than a few seconds (see the DTMF interdigit timer - command 020) the controller assumes that you didn't want to do that command and it throws it away. This keeps a digit accidentally entered from messing up a command you might

enter 30 seconds later (if you didn't unkey in the meantime). It also reduces the likelihood of DTMF voice falsing (see introduction to Chapter 3) causing a command to be executed accidentally; if your voice falses the decoder and you don't unkey for a few seconds, the controller will just discard that falsed digit. There are times, however, when it isn't possible to unkey and it would be handy to have another way to tell the controller to execute. If your repeater squelch gets stuck open or someone sits on their mike, the controller won't be able to tell if you unkey. In this situation, you can enter a command and then force it to execute with the force-execution digit (normally 'D', but can be changed with this command). If your radio doesn't have 'D' on the DTMF keypad, you won't be able to do this. Another situation is when you call in on the reverse autopatch; you can't unkey and most phones don't have the 'D' key. In either of those cases, you might want to turn on timed execution. When timed execution is turned on, instead of throwing a command away if you pause for a few seconds, the controller executes it. This is the preferred method of entering commands on the reverse autopatch. If you use it, you will probably want to shorten the DTMF interdigit timer (see command 020) to 2 or 3 seconds. This option is typically only used on radio ports if you are controlling from a radio that doesn't have 'D' on its DTMF keypad. This option is not available (the setting is ignored) for commands entered from the serial port.

The Force-Execution Digit:

As mentioned previously, the force-execution digit tells the controller to immediately execute any command that may have been entered, without waiting for you to unkey. It is recommended that you leave this digit set to 'D' in most cases, but if you need to change it, 'A', 'B', 'C' and '*' are other acceptable choices ('*' works pretty well from the reverse autopatch if you don't want to use timed execution). Please note that you will not be able to use any commands that have the force-execution digit in their names, so avoid that digit when setting up command names. If you use '*' as the force-execution digit for your repeater port, you will not be able to use '*' as your autopatch up code. If you use the DTMF mute bypass feature (see introduction to Chapter 3), your choice of force-execution digit will affect that as well.

On the serial port, the force-execution digit defaults to 'D' for consistency with the radio ports, but since you can always hit enter and you will sometimes want to use 'D' in your comments, it is recommended that you change the force-execution digit for the serial port to '!' or other uncommon character.

Advanced Note:

If you are trying to change the force-execution digit for one port (call it 'A') by entering this command on another port (call it 'B'), you will be unable to change A's force-execution digit to be the same as B's. This is because when port B sees that digit, it can't tell whether you want it to execute immediately or whether that is what you are trying to change A's force-execution digit to. The easy solution is to enter this command from the port that you are trying to change. If you must enter it from another port, temporarily change the force-execution digit for B, then change it for A, then change B back to what it was. If you didn't understand this paragraph, just ignore it.

079: Recall Command Entry Options for a Port

This command allows you to recall all of the options that were set with command 078.

```
<079> p
```

Parameters:

- 079 is the default command name.
- P is the port for which to change the force-execution digit
 - 1..3 indicate the corresponding port (3 is the autopatch)
 - 4 indicates the serial port

Defaults:

- Chaining is disabled
- Timed execution is disabled
- All ports' force-execution digits default to the 'D' key

080: Execute Command by Number

This command executes other commands without regard to what their names are. In other words, if you know the number of the command as shown in the manual, you can execute it without knowing its name by using this command. It is automatically named “N” rather than “080” as you would normally expect, which means it can only be executed from the serial port unless you rename it (since DTMF pads don’t have the letter “N”). The purpose of this command is explained in the notes below.

```
<080> XXX D..D
```

Parameters:

<080> is the name of this command, normally “N”. See notes below.
 XXX is the *number* of the command you wish to execute
 D..D is the data required by command XXX, if any

Notes:

Since this command makes it easy to execute commands without considering if their names have been changed, renaming commands does not provide much security from someone trying to mess up the programming from the serial port. If access to the serial port can not be controlled (if you have a modem connected to it, for example), you should use the password system to secure the controller. This command does not bypass the password system; if a password is necessary to execute a command directly, the password will still be required if you use this command.

The purpose of this command is to make it easier to program the controller from a computer. One of the best ways to program the controller is to use a text editor (“Notepad” works well in Microsoft Windows™) to create a file that contains all of the commands needed to set up the controller. Such a file can be “uploaded” to the controller using a communications program. A small example of such a file is shown below (note that everything following a ‘;’ (semicolon) until the end of the line is a comment):

```
; Setup file for repeater controller
007 11 ;           turn on DTMF mute for port 1
000 11 ;           make port 1 a repeater
010 000 A12 ;      rename command 000 to “A12”
```

After uploading a file like the one above, you might notice an error in the file or decide to add something else to the file. After making the changes with the editor, you can upload the file again. During this second upload, the line “000 11” will cause a “Command name not found” error because command 000 was renamed during the previous upload. To avoid this problem, you can either reinitialize the controller before each upload (see Appendix D) or you can modify the file as shown below:

```
; Setup file for repeater controller  
N007 11 ;          turn on DTMF mute for port 1  
N000 11 ;          make port 1 a repeater  
N010 000 A12 ;     rename command 000 to "A12"
```

By inserting an "N"(the name of this command, 080) at the beginning of each line, the controller will ignore any name changes and will allow you to upload the file multiple times without errors.

164: Recall Software Version

This command allows you to recall the software version that the controller is running, which might be useful when calling for technical support. Do not be concerned if the controller software version is later than your manual version, as many of the changes between software versions do not require manual changes.

<164>

Parameters:

- 164 is the default command name

165: Reset COP Watchdog Timer

This command allows you to reset the COP watchdog timer from within a macro. The only time this should be needed is if you are executing an extremely long macro sequence (many macros calling each other). If such a macro sequence takes too long to execute, it will cause the controller to reset, because the controller thinks that something is wrong. Executing this command in the middle of such a long macro sequence will tell the controller that everything is ok; it is just taking a long time.

<165>

Parameters:

- 165 is the default command name

Advanced Information:

The COP timer is actually a hardware timer (in the DS1232 chip) that automatically resets the controller if the controller gets stuck in a loop. To keep it from resetting the controller, the software must pulse a pin on the chip at least every second or so to tell the chip that the Computer is Operating Properly (hence the name COP timer). On our controllers, that pin is pulsed in the main loop, from which all of the procedures and functions are called. If there is a bug in any of those procedures or functions that makes it take longer than a second or so (a long time for a computer) to return to the main loop, the COP timer resets the controller. It is possible to write enough long macros that call other long macros so that when the controller executes them it takes longer than a second and thereby fools the COP timer into thinking that there is a problem and causes the controller to reset. If that happens, you can call command 165 in the middle of those long macros to manually tickle the COP and keep it from resetting the controller. That is the only use for this command.

166: Display Status Screen

This command (when finished) will send formatted screens of information about the controller out of the serial port.

```
<166> s
```

Parameters:

- 166 is the default command name
- S is the number of the status screen to display

167: Do Nothing

This command does nothing. After executing, it returns an OK error code like most other commands do. It is used as the default command to execute for commands like Command 157.

```
<167>
```

Parameters:

- 167 is the default command name

014..019: Not Currently Used
033, 034: Not Currently Used
067..069: Not Currently Used
081, 081: Not Currently Used
089: Not Currently Used
096..099: Not Currently Used
109: Not Currently Used
117..118: Not Currently Used
140: Not Currently Used
153..154: Not Currently Used
168: Not Currently Used
192..194: Not Currently Used
197: Not Currently Used

Chapter 18: 500 User Structure

The Password System

The RLC-Club provides several features that allow you to protect it from unwanted access. They range from very simple to extremely secure. Of course the more secure methods are also more complicated. If you don't need a lot of security, don't worry about the advanced password features. This section discusses just the password structure. Other ways of adding security are changing command names (see commands 010, 011, 012 and 062) and blocking access to commands from certain ports (see commands 130, 131 and 132). The password system is disabled when the controller is shipped and after you re-initialize it (which sets everything back to defaults), so you don't have to worry about entering passwords until you are ready for it.

The password system allows you to require that users "log in" to the controller before they will be able to execute some or all of the commands. You can even allow some users, such as control operators, more access than others. This is accomplished by assigning each user a "user level" which determines how much they are allowed to do. User levels can range from 0 to 7. Typically, the owner of the system would be level 7, control operators level 6.3 (more on that later), and other Club members level 2.1. Level 7 users always have access to every command in the controller. A good rule is to assign lower levels to commands that are less important. For example, lower level users can not access higher level commands, but higher level users can access lower level commands.

When the password system is enabled, the RLC-Club requires a certain user level to execute each command. The commands default to suggested levels, but you can change them if you wish. When someone logs into the controller and tries to execute a command, their user level must be equal to or greater than the level required by that command, or the RLC-Club will not let them execute the requested command. The command for setting up passwords is a level 4 command, so only users that are level 4,5,6 or 7 can set passwords. The command to change which ports are connected together is level 4, so user levels 4, 5, 6 and 7 can bring up links, set up crossband repeaters, etc. Commands that are assigned level 0 can always be executed by anyone, even if they do not log into the controller first. Recalling the time is an example of a level 0 command.

You will need to tell the controller what each user's level is, and assign them a password, callsign, autodial number and other information for each user. To keep track of this information, you will need to assign each user a number between 001 and 500. We will call this their "user number". It will also be their autodial slot number, their paging slot number, etc. They will have to tell the controller what their user number is, along with their password, to log in. For the purpose of examples in the manual, we will consider the owner to be user 001, the control operators to be 002 through 009, and the rest of the Club members 010 through 500, although it doesn't really matter whether you are user 003 or 300.

When someone tries to execute a command without logging onto the controller, the controller doesn't know who they are, so it considers them to be user 000. If they try to execute a command without logging onto the controller, the controller will compare the user level required to execute that command with the user level for user 000. If user 000 is set to be level 7, they will be able to

execute any command in the controller without logging on. This is how the password system is disabled when the controller is shipped or after you re-initialize. If user 000 is set to level 0, they will only be able to execute level 0 commands (like recalling the time) without logging on. If user 000 is set to level 2, they will be able to use the autopatch without logging on.

If you decide you want to enable the password system, you should first set up a password for yourself and assign yourself a user level (see command 186):

Example:

```
186 001 1 7 0 1234 ; user 001, enabled, level 7, fixed password 1234
```

Now you can try logging in. First check and see if anyone else is logged in by entering Command 188 and unkeying. Now log in by entering Command "187 001 1234", where 187 is the login command, 001 is your user number and 1234 is your password. The controller should respond and tell you that it accepted the command. Now enter Command 188 and note that you are logged in. Now logout by entering Command 189 and unkeying. Command 188 will confirm that you are no longer logged in. You will also be logged out automatically if you do not enter a valid command for 60 seconds (you can change the automatic logout timer with Command 020).

Example:

Set up user 002 as a control operator (or yourself for now). Assign them a different password.

```
186 002 1 6 0 4321 ; user 002, enabled, level 6, fixed password 4321
```

Try logging in as user 002. It is important to set up and test two different users before continuing to enable the password system, to prevent you from accidentally locking yourself out of the controller.

```
187 002 4321 ; log in as user 002
189 ; log out
```

Remember that when no one is logged in, the controller considers you to be user 000. Up to this point, user 000 has been a level 7 user and could execute any command. Now we will change user 000 to a level 0 user, so that only level 0 commands like reading the time can be executed without logging on. ***Make sure you have followed the example up to this point and can log on as a level 6 or 7 user, or this will lock you out of the controller.***

```
186 000 1 0 ; enable the password system
```

To disable the password system (you may have to log on first):

```
186 000 1 7 ; disable the password system
```

Note that there is no reason to program a password for user 000, since everyone is user 000 until they log in. Now enter Command 009 to try and recall the crosspoint settings. If you are not logged in, the controller won't let you (that is a level 4 command). Log in as user 001 or 002 as described above and try Command 009 again. You can check to see if you are logged in by entering Command 188.

If you want your Club members to be able to use the autopatch and remote base and do other common things without logging on, but you still want your control operators to have to log on to change how the controller is programmed, log on, enter the command sequence for Command 186 000 1 2. This sets user 000 to level 2. If you do this, everyone will be able to execute level 0, 1 and 2 commands without logging in.

If you want to turn the password system off, log on and enter the command sequence for Command 186 000 1 7. This sets user 000 to level 7. If you do this, the controller will allow all commands to be executed without logging on.

Before setting up the rest of the users, you should consider how secure you want your system to be and choose from the following methods of logging into the controller. ***Before experimenting with these methods, make sure that you are able to log on as at least TWO different users, both level 7. Otherwise if you mess up, you might not be able to log in. A secure system can lock you out too!***

Method #1 - No Passwords:

To log on with this method, you have to tell the controller your user number, but you don't have to enter a password. This is useful when you want to require people to log on to execute commands so you know who they are, but it doesn't provide much security. It is easy to log on as someone else, because you don't have to know their password. To set up user 001 with no password, enter Command 186 001 0. User 001 can log on with Command 187 001.

Method #2 - Fixed Passwords:

We have already used this method in the examples above. With fixed passwords, you log onto the controller by entering Command 187 followed by your user number and your password, for example "187 001 1234". You can make your password up to eight digits long. For example, using Command 186 001 1 7 0 12345678, user 001 is assigned a fixed password of 12345678. Longer passwords are obviously harder to guess, but if someone is decoding your DTMF tones, they will probably be able to figure out your password no matter how long it is. Even so, fixed passwords are probably secure enough for most Club members, and possibly secure enough for even the owner and control operators.

Method #3 - Challenge Passwords:

When a user with a challenge password logs in, it takes two steps. First you enter the logon command (Command 187) followed by their user number excluding the password information. The controller looks the user number, finds out that the user is configured for a challenge password entry, and issues the challenge by requesting the user to enter certain randomly selected digits of his password. The user then re-executes Command 187 followed by those digits of the users password that the controller asked for. An example will probably make this a lot more clear. You will have to logon before trying this example, since command 186 is a level 6 command.

Example:

```
186 003 1 6 3 ABCABC      ; user 003, enabled, level 3, password ABCABC
187 003                  ; request to login
; controller responds with "Please enter 2, 6, 3"
187 B C C                ; enter 2nd, 6th, and 3rd digit of password
; controller responds with logon message
```

Command 186 told the controller that user 003 wanted a 3 digit challenge password of ABCABC. "Command 187 003" told the controller that user 003 was trying to login. The controller knew (because of command 186) that user 003 needed a three digit challenge. It randomly chose to ask for the 2nd, 6th, and 3rd digit of the password. After the controller issues such a challenge, the next time command 187 is executed, it should be the answer to the challenge. In this case, user 003 entered the three digits that the challenge asked for, as you can see below:

Requested digits:	1	2	3	4	5	6
Password digits:	A	B	C	A	B	C

The 2nd, 6th and 3rd digit of the password are "B C C".

The challenge password method is more secure than the fixed password method, because if someone decodes your DTMF digits as you enter your password, they don't learn your entire password, but only those digits they you enter. If they try to logon using your password, the challenge will likely ask for a digits they don't know.

The challenge will never ask for the same digit twice, so the challenge can't ask for more digits than the length of your password. For the most security, it is recommended that you use at least six and preferably eight digits (the maximum length) for your password and have the challenge ask for three or four digits.

Method #4 - Challenge Passwords with Decoy Digits:

While the method #3 is very secure, if someone decodes your DTMF digits as you log on many times, they will eventually learn all of the digits of your password. Using "decoy digits" makes it much more difficult to figure out a password by decoding the digits.

The controller doesn't require you to enter decoy digits, but it allows it if you have a challenge password. Consider the challenge password that was set up for user 003 in the example for method #3.

187 003 ; request to login
; controller responds with "Please enter 2, 6, 3"

Now instead of entering: "187 B C C" like with method #3, enter "187 5 3 A B C C B". Note that "B C C" still appears in the digits entered. The other digits ("5 3 A" and the final "B") are not needed; they are just "decoy" digits and are ignored by the controller. But someone decoding your DTMF tones doesn't know which digits are the decoy digits and which ones are digits 2, 6 and 3 of your password. So even if they decode your DTMF digits as you log on dozens of times, they probably won't be able to figure out your password.

All you have to do to use method #4 is request to log in ("187 003" for example), figure out what digits the controller is asking for, then enter 187, some decoy digits, the digits the controller asked for, and some more decoy digits. You should randomly choose from all of the DTMF digits (except the force-execution digit which defaults to 'D') for your decoy digits. You can use from 0 up to 8 or so decoy digits before and again after the digits the controller asks for.

Remember that the whole purpose of the decoy digits is to keep someone that is listening and decoding your tones from figuring out which of the digits you enter are the decoy digits and which ones are the answer to the challenge. Use different decoy digits each time. Try to enter the decoy digits at the same rate that you do the other digits.

If all of this password stuff sounds too complicated, remember that using a challenge password with decoy digits is only needed to deal with extreme security problems. You will probably be just fine with no passwords and just changing a few of the important command names or with Method #1 fixed passwords.

186: Set up User Password

This command allows the system manager to set-up a user's password. Once the password is set, the user must then enter the correct sequence to access commands higher than level 0.

<186> uuu	Recall a user's password information
<186> uuu e	Enable/Disable a selected user
<186> uuu e l	Enable/Disable a selected user and set the user level
<186> uuu e l t p..p	All of the above plus enter password information

Parameters:

UUU - user number

E - enabled/disabled

T - password type (0 = fixed. 1 or more is number of challenge digits) 

P..P - your password (8 digits max)

Notes:

- Can enable or disable a user by only entering through E.
- If choose a password type of 0 but don't enter a password, you will be able to log in by just entering the name of command 187 followed by your user number (password method #1).

187: User Log-on

This command is the actual command the user uses when accessing high level commands. Because of the importance of this command it can never be assigned an access level higher than '0'. By correctly entering password information, the user can log-on to the controller and have access to all commands that are assigned a level equal or less than their level.

<187> uuu p..p	Fixed password where p..p is the length of 'uuu' password
----------------	---

or...

<187> uuu <unkey> <voice prompt speaks the users required entries> then <keyup> and p..p	Challenged password where p..p are the digits from 'uuu' password table.
--	--

Parameters:

- 187 is the default command name
- UUU is the user number (000..999)
- P..P is the password data



Notes:

If a password is challenged the user must unkey and allow the controller to prompt them with the digits to enter from their custom password table.

188: Recall Who Is Logged In

This command tells you who, if anyone, is logged in. If someone is causing problems, you can find out who they are (or at least who they are logged in as) with this command. If you have not been monitoring and you want to log on to the repeater, you should use this command first to find out if someone is already logged in.

If no one is logged in when you execute this command, it will speak "clear".

<188>

Parameters:

-188 is the default command name

189: User Log-off

Once a user has completed their needs on the system, they should log-off. Once off the system they must again log-on in order to execute any system commands assigned a level higher than '0'.

<189>

Parameters:

-189 is the default command name

Notes:

If the controller should lose power while you are logged off, it will automatically log you off when power is restored so no one else can control without logging on. Actually, everyone is automatically logged off whenever the controller is reset for any reason.

190: Assign a User Level to a Command

This command assigns a user level to a command name, or a range of command names. The commands default to reasonable levels, but you can change them to anything you wish.

<190> ccc	Recall level of a single command
<190> ccc l	Set the level for a single command
<190> ccc eee	Recall the level for a range of commands
<190> ccc eee l	Set the level for a range of commands

Parameters:

CCC is the command number from 000..500

L is the level assigned

- 0 is the lowest level with no log on required

- 7 is the highest level of log on

EEE is the ending command number for entries that require this data

Notes:

- The controller will not let you use a larger value for **L** than your user level. This is to keep you from locking yourself out of the controller.

- If a command currently has a level higher than your user level, you will not be able to change it. This is to keep lower level users from gaining unauthorized access.

- You cannot change the level of the logon command; it is always 0. This is necessary to avoid locking yourself out of the controller.



191: Assign a Callsign to a User

This command assigns a callsign to a user number. User 14 might be KC7HXB for example. This callsign is used when the controller speaks messages about logging on and off and in several other places. It is possible to use a different name for a user instead of their callsign. The default "callsigns" are just the user number; user 14 is "zero one four". The "callsign" can consist of any words listed in Appendix B. This includes all of the numbers and letters and the special words like the current time.

<191> uuu	Recall user callsign
<191> uuu www..www	Set the user callsign

Parameters:

- 191 is the default command name
- UUU is the user number (000..500)
- www..www is a list of word numbers from Appendix B. There is a limit of 8 words per user number.



Notes:

- These callsigns are normally used for the autodial slot with the same number. You can keep the callsigns from being used for the autodials with command 126.

Chapter 19: The Beacons System

The beaconing system was designed to alert you when something at the site needs your attention. It can be set up to announce a message over the radio and/or call you using the autopatch. It can beacon a limited number of times, or indefinitely until you cancel the beacon. An example follows:

```
; This is a file to set up the club to do beacon using both the radio and the autopatch.
; To start a beacon, enter "SPEAK: 01 THIS_IS_A_TEST" (or any other message with
; underscores separating the words) from the serial port. The beacon message will be
; announced out radio port 1 twice, then the phone will be dialed and the message
; will be announced four times before hanging up. Then the process starts over. This
; will continue until the beacon is cancelled by entering "###".
```

```
N050 0 ;          turn voice off during upload
N078 4 0 0 ! ;    change force-execution digit to ! from D for serial port
N078 3 0 1 ;      turn timed execution on for autopatch
N020 053 2 ;      set timed execution timer to 2 seconds from 5
```

```
N002 11 ;         turn repeater mode off, uses a transceiver
N085 10 ;         turn ID's off
```

```
N110 10 ;         enable autopatch - no number readback
N133 2 02 123 ;   enable reverse patch - logon code 123
N072 3 ;          turn preaccess off for patch so don't need logon code
```

```
N045 01 297 02 0005 02 0 1 ;    beacon out radio port one twice, then go to patch
N045 02 297 04 0002 01 1 <phone number> ; beacon out phone four times, then go to radio
```

```
N010 048 SPEAK: ;    rename special beacon command
N010 047 ### ;       cancel command
```

Note:

If you have two beacons in a row set up to go to the autopatch, and the patch never hangs up between them, you may need to shorten the hang timer for the autopatch port to less than a second.

045: Setup Beacon Table

This command allows you to set up the beacon table. It is this table that controls what happens when a beacon is started. The different slots in the table can be used to alert you of different things, or they can be used together (when N is set to 01..50) to alert you in several different ways, such as by radio and by telephone.

<045> SS	Recall slot SS
<045> SS MMM XX TTTT NN T D..D	Set slot SS

Parameters:

045 is the default command name.

SS = beaconing table slot number to set up/recall: 01..50. If this is the last parameter entered, will recall the current settings of the slot in the table.

MMM = macro/command number to do

XX = number of times to do it

TTTT = time to wait between in seconds between calls to MMM. If the message spoken in command/macro MMM uses the controller's synthesized voice or DVR and it takes longer than this timer is set for, the controller will wait until the message is done. This timer should be set fairly short (less than 5 seconds) when T=1 (autopatch), so when you answer the phone you won't have to wait a long time before you hear the message.

NN = next beaconing table slot to do (01..50), or
00 = stop after done with this slot

T = type of beacon to do

0 = beacon out radio port(s)

D..D = list of radio ports, audio routing

1 = beacon out of autopatch

D..D = phone number to dial

046: Start Beacon

This command starts a beacon using the table you set up with command 045. You can start with any of the beacon table slots, so different conditions can start different messages.

```
<046> SS
```

Parameters:

046 is the default command name.

SS = beaconing table slot number to start with (01..50)

047: Cancel Beacon

This command allows you cancel a beacon after it has been started. Since only one beacon can be active at a time, you don't have to specify which one you want to cancel.

```
<047>
```

Parameters:

047 is the default command name.

048: Start Beacon Using English Words

This command allows you to start a beacon from the serial port that will speak the message you specify using English words. It automatically programs macro 297 (and possibly 298) to speak the message you specify (see command 066 for more details) and starts beaoning using the beacon table slot you specify (which should be set up ahead of time to call macro 297). This command is most useful for alerting you of errors that occur in another system that can output a serial error message and execute this command. Any word that is not in the controller's voice library (see Appendix B) will be spelled out.

```
<048> SS Error_message_in_English_words
```

Parameters:

048 is the default command name.

SS is the beacon slot number to use (often is 01)

Error_message_in_English_words is the message to be spoken, with the words separated by underscore digits.

Example:

```
048 01 This_is_a_test_error_message
```

Chapter 20: Event Triggers

The controller does a lot of things totally under the control of the built-in firmware which you as the user can't change, such as turning on a PTT when a receiver goes active and hanging up the phone when it times out. Other things are done by calling automatic macros (see Chapter 8), such as sending ID's and courtesy beeps. Although you can't control when the automatic macros get called, you can control what they do. Event triggers give you even more flexibility. They allow you to execute any of the built in commands or any of the macros whenever certain things happen. All you have to do is tell the controller what command you want to do when each event occurs with command 157. If you only want it to happen some of the time, you can just disable the event trigger with command 159. If you tell the event trigger to execute a macro, you may need to program the macro to do something (see Chapter 8). You should keep track of what command you assign each event trigger to execute, as you may need to know later.

If you want to execute more than one command from an event trigger, make the event trigger call a macro, then program the macro to execute each of the commands in turn. That way the event trigger calls only a single macro and the macro takes care of calling multiple other commands.

157: Set Up Event Trigger

This command allows the user to assign a macro or command call when an event occurs in order to get response or action to occur. These are useful for alarming, and interrogating events that occur.

```
<157> eee ccc
```

Parameters:

- 157 is the default command name
- EEE is the Event Number (see table below)
- CCC is the command number to call when an event occurs

Default:

- All events are disabled
- When an event is programmed, the event is enabled

158: Recall Event Trigger Setting

This command allows the recall of what macro or command an event will jump to when a change occurs.

```
<158> eee
```

Parameters:

- 158 is the default command name
- EEE is the Event Number

Default:

All events are disabled

159: Enable/Disable Event Trigger

This command allows the enable/disable control of the automatic event calling.

<159> eee 1	Enable an event
<159> eee 0	Disable an event

Parameters:





- 159 is the default command name
- EEE is the Event Number

Default:

All events are disabled

Event Table:

000 - COR Active Port 1	044 - Port 1 DTMF Active *
001 - COR Active Port 2	045 - Port 1 DTMF Active #
002 - Reserved	046 - Port 2 DTMF Active 0
003 - COR Inactive Port 1	047 - Port 2 DTMF Active 1
004 - COR Inactive Port 2	048 - Port 2 DTMF Active 2
005 - Reserved	049 - Port 2 DTMF Active 3
006 - PL Active Port 1	050 - Port 2 DTMF Active 4
007 - PL Active Port 2	051 - Port 2 DTMF Active 5
008 - Reserved	052 - Port 2 DTMF Active 6
009 - PL Inactive Port 1	053 - Port 2 DTMF Active 7
010 - PL Inactive Port 2	054 - Port 2 DTMF Active 8
011 - Reserved	055 - Port 2 DTMF Active 9
012 - Port Active Port 1	056 - Port 2 DTMF Active A
013 - Port Active Port 2	057 - Port 2 DTMF Active B
014 - Autopatch Active	058 - Port 2 DTMF Active C
015 - Port Inactive Port 1	059 - Port 2 DTMF Active D
016 - Port Inactive Port 2	060 - Port 2 DTMF Active *
017 - Autopatch Inactive	061 - Port 2 DTMF Active #
018 - Any Connected RX Active 1	062 - Patch DTMF Active 0
019 - Any Connected RX Active 2	063 - Patch DTMF Active 1
020 - Any Connected RX Active Patch	064 - Patch DTMF Active 2
021 - All Connected RX Inactive 1	065 - Patch DTMF Active 3
022 - All Connected RX Inactive 2	066 - Patch DTMF Active 4
023 - All Connected RX Inactive Patch	067 - Patch DTMF Active 5
024 - Any DTMF Active Port 1	068 - Patch DTMF Active 6
025 - Any DTMF Active Port 2	069 - Patch DTMF Active 7
026 - Any DTMF Active Port Patch	070 - Patch DTMF Active 8
027 - Any DTMF Inactive Port 1	071 - Patch DTMF Active 9
028 - Any DTMF Inactive Port 2	072 - Patch DTMF Active A
029 - Any DTMF Inactive Port Patch	073 - Patch DTMF Active B
030 - Port 1 DTMF Active 0	074 - Patch DTMF Active C
031 - Port 1 DTMF Active 1	075 - Patch DTMF Active D
032 - Port 1 DTMF Active 2	076 - Patch DTMF Active *
033 - Port 1 DTMF Active 3	077 - Patch DTMF Active #
034 - Port 1 DTMF Active 4	078 - Tried to hang up patch when was already hung up.
035 - Port 1 DTMF Active 5	079 - Before turn HF mode on
036 - Port 1 DTMF Active 6	080 - After turn HF mode off
037 - Port 1 DTMF Active 7	081 - HF Band 160m
038 - Port 1 DTMF Active 8	082 - HF Band 80m
039 - Port 1 DTMF Active 9	083 - HF Band 40m
040 - Port 1 DTMF Active A	084 - HF Band 30m
041 - Port 1 DTMF Active B	085 - HF Band 20m
042 - Port 1 DTMF Active C	086 - HF Band 17m
043 - Port 1 DTMF Active D	

- 087 - HF Band 15m
- 088 - HF Band 12m
- 089 - HF Band 10m
- 090 - HF Band 6m
- 091 - HF Band 2m
- 092 - HF Band 125cm
- 093 - HF Band 70cm
- 094 - HF Band 33cm 
- 095 - HF Band 23cm 
- 096 - HF Band Other
- 097 - Hang Up Command 115 Blocked
- 098 - Tail Msg 1 TX 1
- 099 - Tail Msg 2 TX 1
- 100 - Tail Msg 3 TX 1
- 101 - Tail Msg 1 TX 2
- 102 - Tail Msg 2 TX 2
- 103 - Tail Msg 3 TX 2 
- 104 - Tail Msg 1 Patch
- 105 - Tail Msg 2 Patch
- 106 - Tail Msg 3 Patch
- 107 - Autopatch Line Sense Hangup. Enter 157 107 114 to make the patch automatically hang up when the phone hangs up. Audio is routed to nowhere by default. If call the hangup command, it automatically routes to the correct ports. 
- 108 - Reverse Patch Answered - default audio routing is to the autopatch port.

Notes about the Event Triggers:

Tail Messages: There are three tail messages assigned to each transmitter. They can be used to indicate that you are on battery power, that a link is up, to announce club meetings, etc. If you transmit PL from your repeater, you may want to consider turning the PL encoder off and sending a cw pause from a tail message to make your PL go away before the repeater actually drops (you could turn the PL encoder back on from the "any connected receiver active" event trigger). You can enable any one, two, or all three tail messages at the same time. The controller will send them in order after the courtesy beep (if on a repeater) and hang time are over. They will normally be the last thing sent before the transmitter drops (the mini-hang time is all that happens afterward). To keep them from getting too annoying, they will be sent no more often than the length of the tail message timers (see Chapter 4), which defaults to 5 minutes. If you set the tail message timers to 0, they will be sent every time the transmitter drops. If you key up while a tail message is being sent, it will start the cycle over again; that is the tail message will be sent again after you unkey, and the courtesy beep and hang timer are done.



Appendix A: The Audio Routing Variable System

Explanation of the System

The key to controlling messages on the RLC-Club is understanding what the audio routing variable needs to be in each different situation. Fortunately, the RLC-Club does most of the work for you. When any command is executed by the user (either by DTMF or the serial port) or by the controller itself (to send an ID, courtesy beep, etc.), the audio routing variable is automatically set to send the audio to the logical place. You only need to concern yourself with this information if you wish to change the way the audio is routed. The value of the audio routing variable in several situations is listed below:

- When a command is executed by DTMF, the audio routing variable is set to send all of the responses to the port that the DTMF input came from.
- Before a time out, time out clear, or any ID macro is executed, the audio routing variable is set to send the message to the relevant port.
- Before a courtesy beep is sent, the audio routing variable is set to send the beeps to the right ports (repeater ports connected to the receiver that just unkeyed).

You probably noticed in the list above that the audio routing variable automatically sends the audio where you would normally want it to go. The only reason you need to know about it is because there are a few situations where the controller can not know correct audio routing.

Suppose, for example, that you want the scheduler to cause the time to be read at the top of every hour. How could the controller know that you want only ports 1 and 2 to hear the message? It can't. There are two ways for you to specify where messages from the scheduler go. First, choose where you want most of the messages caused by the scheduler to go. Tell the controller what ports those are with Command 050. Now all of the messages caused by the scheduler will go out those ports. What if you want one of the messages caused by the scheduler to go somewhere else? Simply make the scheduler call a user macro and program the first command in the macro to be Command 037 D or unkey and list the ports where you want the message to go to. This will change the audio routing variable for the rest of the commands in the macro. Command 037 can be used to change where the messages generated by any macro will go. All commands executed after Command 037 in a macro until the end of that macro will go to the ports specified with Command 037.

A similar situation exists for commands entered from the serial port. Since the controller sends serial responses to the commands that you execute, you don't have to worry about voice responses if you don't want to. There are times, however, when you want to hear the voice messages that are generated. You can use Command 050 to specify which ports get the audio that is caused by the serial port. The RLC-Club defaults to sending these messages out of port one, but you can send them to any ports you want to, or to no ports at all.

Suppressing Command Responses in Macros:

There is one other time when you will often want to change the audio routing variable. Suppose that you have programmed macro 467 to connect ports 2 and 3 (the autopatch) to the main repeater on port 1. Your macro would probably execute Command 000 12 D or unkey and Command 000 13 D or unkey to do this. The voice responses from these commands would be "1 connect 2 on, 1 connect 3 on". It wouldn't take very long to get tired of hearing that long message. To replace it with a nice short message like "link on" (word numbers 218 and 264), do the following:

Insert Command 038 (suppress audio) as the first command in the macro:

Command 059 467 00 038 D or unkey or <Enter>

If you executed the macro at this point, it would be silent.

Insert the new voice message even before that:

Command 059 467 00 036 218 264 D or unkey or <Enter>

Now the macro will do the following:

Speak the voice message "link on" (command number 036)

Suppress the audio (set the audio routing variable to no ports, command number 038)

Connect ports 1 and 2 (throws the voice responses away)

Connect ports 1 and 3 (throws the voice responses away)

The same process can be used to suppress or change the voice response from any macro. Any commands that are executed after Command 038 in a macro will be silent.

Appendix B: Voice Word Table

Romeo's words (words 000..543):

These words make up the main vocabulary of the controller. They are arranged with the numbers first, then the alphabet, then alphabetically.

Prefixes and Suffixes (words 544..552):

These are really parts of words. They can be used in combination with other words to make some new words. For example, you can use words 311 and 549 together to form the word "meetings".

Juliet's words (words 553..586):

These are used primarily for time and date. They are not intended to allow you to run the whole controller with the female voice.

Pause (word 587):

Word 587 is listed as "pause". It causes the voice to pause for a moment, such as between sentences. It does not speak the word "pause". It can be used in combination with any of the other words.

Sound Effects (words 588..598):

Try them!!!

Junior's words (599..685):

Romeo quit the recording business, so we had to get Junior to record some other words for us. Some words were recorded by both Romeo and Junior, so you might want to check both places in the word list. It usually sounds best if you don't mix words from the two lists in one message, but sometimes that is the only way to get the words you want.

Variable words (810..919):

Most of these words allow you to insert a message that is not always the same into a voice message, such as the current time. If you want to include the time in one of your ID's, for example, you could just include word 810 in the ID message. "At <the time>, this-is the XXXXX repeater" would be word numbers 086, 810, 480, 475, 054, 054, 054, 054, 411. These words make it easy to write custom messages that read the time, date, I/O lines, etc.

Word List:**Romeo's Words**

000 ZERO	042 L	086 AT
001 ONE	043 M	087 AUGUST
002 TWO	044 N	088 AUTO
003 THREE	045 O	089 AUTOMATIC
004 FOUR	046 P	090 AUTOPILOT
005 FIVE	047 Q	091 AUXILIARY
006 SIX	048 R	092 AVON
007 SEVEN	049 S	093 AVON MOUNTAIN
008 EIGHT	050 T	094 A.M.
009 NINE	051 U	095 BAND
010 TEN	052 V	096 BANK
011 ELEVEN	053 W	097 BASE
012 TWELVE	054 X	098 BATTERY
013 THIRTEEN	055 Y	099 BELOW
014 FOURTEEN	056 Z	100 BETWEEN
015 FIFTEEN	057 ABORT	101 BLOWING
016 SIXTEEN	058 ABOUT	102 BLUE KNOB
017 SEVENTEEN	059 ABOVE	103 BOARD
018 EIGHTEEN	060 ACKNOWLEDGE	104 BOOST
019 NINETEEN	061 ACTION	105 BOZO
020 TWENTY	062 ADJUST	106 BRAKE
021 THIRTY	063 ADVANCED	107 BRAVO
022 FORTY	064 ADVISE	108 BREAK
023 FIFTY	065 AERIAL	109 BROKEN
024 SIXTY	066 AFFIRMATIVE	110 BUSY
025 SEVENTY	067 AIR	111 BUTTON
026 EIGHTY	068 AIRPORT	112 BY
027 NINETY	069 AKRON	113 CABIN
028 HUNDRED	070 ALERT	114 CALIBRATE
029 THOUSAND	071 ALL	115 CALL
030 MILLION	072 ALOFT	116 CALLING
031 A	073 ALPHA	117 CALM
032 B	074 ALTERNATE	118 CANCEL
033 C	075 ALTITUDE	119 CAUTION
034 D	076 AMATEUR	120 CEILING
035 E	077 AMPS	121 CELSIUS
036 F	078 AND	122 CENTER
037 G	079 ANSWER	123 CHANGE
038 H	080 APPROACH	124 CHARLIE
039 I	081 APRIL	125 CHECK
040 J	082 AREA	126 CIRCUIT
041 K	083 ARRIVAL	127 CLEAR
	084 AS	128 CLIMB
	085 ASSOCIATION	129 CLOCK

130 CLOSED	177 ECHO	224 GO
131 CLUB	178 ELECTRICIAN	225 GOLF
132 CODE	179 ELEVATION	226 GOODBYE
133 COLUMBUS	180 EMERGENCY	227 GREEN
134 COME	181 ENGINE	228 GREENWICH
135 COMPLETE	182 ENTER	229 GROUND
136 COMPUTER	183 EQUAL	230 GURNEE
137 CONDITION	184 EQUALS	231 GUSTINGTO
138 CONGRATULATIONS	185 ERROR	232 HAIL
139 CONNECT	186 ESTIMATED	233 HALF
140 CONNECTICUT	187 EVACUATE	234 HAM
141 CONTACT	188 EVACUATION	235 HAMFEST
142 CONTROL	189 EXIT	236 HAMVENTION
143 CONVERGING	190 EXPECT	237 HAVE
144 COSHOCTON	191 FAIL	238 HAZARDOUS
145 COUNT	192 FAILURE	239 HAZE
146 COURSE	193 FARAD	240 HEAVY
147 CRANE	194 FAHRENHEIT	241 HELLO
148 CROSSWIND	195 FARMINGTON	242 HELP
149 CURRENT	196 FAST	243 HENRY
150 CUYAHOGA FALLS	197 FEBRUARY	244 HERTZ
151 CYCLE	198 FEET	245 HIGH
152 DALLAS	199 FILED	246 HOLD
153 DANGER	200 FINAL	247 HOME
154 DATE	201 FINDLAY	248 HOTEL
155 DAY	202 FIRE	249 HOUR
156 DAYS	203 FIRST	250 HOURS
157 DAYTON	204 FLAPS	251 ICE
158 DECEMBER	205 FLIGHT	252 ICING
159 DECREASE	206 FLOW	253 IDENTIFY
160 DECREASING	207 FOG	254 IGNITE
161 DEGREES	208 FOR	255 IGNITION
162 DELTA	209 FOURTH	256 IMMEDIATELY
163 DEPARTURE	210 FOXTROT	257 IN
164 DEVICE	211 FREEDOM	258 INBOUND
165 DIAL	212 FREEZING	259 INCH
166 DINNER	213 FREQUENCY	260 INCREASE
167 DIRECTION	214 FRIDAY	261 INCREASING
168 DISPLAY	215 FROM	262 INCREASINGTO
169 DIVIDED	216 FRONT	263 INDIA
170 DOOR	217 FULL	264 INDICATED
171 DOWN	218 GALLONS	265 INFLIGHT
172 DOWNWIND	219 GATE	266 INFORMATION
173 DRIVE	220 GAUGE	267 INNER
174 DRIZZLE	221 GEAR	268 INSPECTOR
175 DUST	222 GET	269 INTRUDER
176 EAST	223 GLIDE	270 IS

271 IT	318 MILL	365 OUTER
272 JANUARY	319 MILLI	366 OVER
273 JULIET	320 MINUS	367 OVERCAST
274 JULY	321 MINUTES	368 PAPA
275 JUNE	322 MIST	369 PARTIALLY
276 KENTUCKY	323 MOBILE	370 PASS
277 KEY	324 MODERATE	371 PASSED
278 KILO	325 MONDAY	372 PATCH
279 KNOTS	326 MONTH	373 PATH
280 LAND	327 MORETHAN	374 PELLETS
281 LANDING	328 MOTOR	375 PER
282 LATE	329 MOUNT HAMILTON	376 PERCENT
283 LAUNCH	330 MOUNT TAMALPAIS	377 PHONE
284 LEAN	331 MOVE	378 PICO
285 LEFT	332 MOVING	379 PLEASE
286 LEG	333 MUCH	380 PLUS
287 LESS THAN	334 NEAR	381 POINT
288 LEVEL	335 NEGATIVE	382 POLICE
289 LIGHT	336 NET	383 POSITION
290 LIMA	337 NEW	384 POWER
291 LINE	338 NEWINGTON	385 PRACTICE
292 LINK	339 NEW HAVEN	386 PRESS
293 LIST	340 NEXT	387 PRESSURE
294 LITTON	341 NIGHT	388 PRIVATE
295 LOCK	342 NO	389 PROBE
296 LONG	343 NORTH	390 PROGRAMMING
297 LOOK	344 NORTHEAST	391 PULL
298 LOW	345 NORTHWEST	392 PUSH
299 LOWER	346 NOT	393 P.M.
300 LUNCH	347 NOVEMBER	394 QUEBEC
301 MACHINE	348 NUMBER	395 RADAR
302 MAINTAIN	349 OAKS	396 RADIO
303 MANUAL	350 OBSCURED	397 RAIN
304 MARCH	351 O'CLOCK	398 RAISE
305 MARKER	352 OCTOBER	399 RANGE
306 MAY	353 OF	400 RATE
307 MAYDAY	354 OFF	401 RATTLESNAKE
308 ME	355 OHIO	MOUNTAIN
309 MEAN	356 OHMS	402 READY
310 MEASURE	357 OIL	403 REAR
311 MEETING	358 ON	404 RECEIVE
312 MEGA	359 OPEN	405 RED
313 MESSAGES	360 OPERATION	406 RELEASE
314 METER	361 OPERATOR	407 REMARK
315 MICRO	362 OSCAR	408 REMOTE
316 MIKE	363 OTHER	409 REPAIR
317 MILES	364 OUT	410 REPEAT

411 REPEATER	458 STORM	505 UNLIMITED
412 RICH	459 SUNDAY	506 UNTIL
413 RICHMOND	460 SWITCH	507 UP
414 RIG	461 SYSTEM	508 USE (NOUN)
415 RIGHT	462 TANGO	509 USE (VERB)
416 ROAD	463 TANK	510 VALLEY
417 ROGER	464 TARGET	511 VALVE
418 ROMEO	465 TARPON SPRINGS	512 VARIABLE
419 ROUTE	466 TAXI	513 VERIFY
420 RUNWAY	467 TEEN	514 VICTOR
421 SAFE	468 TELEPHONE	515 VISIBILITY
422 SAINT PETERSBURG	469 TEMPERATURE	516 VOLTS
423 SAND	470 TERMINAL	517 WAIT
424 SANTA CLARA	471 TEST	518 WAKE
425 SAN LEANDRO	472 THANK YOU	519 WAKEUP
426 SATURDAY	473 THAT	520 WARNING
427 SCATTERED	474 THE (LONG E)	521 WATCH
428 SECOND	475 THE (SHORT E)	522 WATTS
429 SECONDS	476 THE	523 WAY
430 SECURITY	477 THIN	524 WEATHER
431 SELECT	478 THINLY	525 WEDNESDAY
432 SEPTEMBER	479 THIRD	526 WELCOME
433 SEQUENCE	480 THIS IS	527 WEST
434 SERVICE	481 THIS	528 WEST HARTFORD
435 SET	482 THUNDERSTORMS	529 WHISKEY
436 SEVERE	483 THURSDAY	530 WILL
437 SEXY	484 TIME	531 WIND
438 SHORT	485 TIMER	532 WISKEY
439 SHOWERS	486 TIMES	533 WITH
440 SHUT	487 TO	534 WRONG
441 SIDE	488 TODAY	535 X-RAY
442 SIERRA	489 TOMORROW	536 YANKEE
443 SIGHT	490 TONIGHT	537 YELLOW
444 SLEET	491 TOOL	538 YESTERDAY
445 SLOPE	492 TORNADO	539 YOU
446 SLOW	493 TORONTO	540 YOUR
447 SMOKE	494 TOUCHDOWN	541 ZED
448 SNOW	495 TOWER	542 ZONE
449 SOUTH	496 TRAFFIC	543 ZULU
450 SOUTHEAST	497 TRANSMIT	
451 SOUTHWEST	498 TRIM	
452 SPEED	499 TUESDAY	
453 SPRAY	500 TURBULANCE	
454 SQUAWK	501 TURN	
455 STALL	502 UNDER	
456 START	503 UNIFORM	
457 STOP	504 UNIT	
		<i>Prefixes and Suffixes</i>
		544 FIF-
		545 THIR-
		546 -ED
		547 -ER
		548 -ING

549 -S
550 -TEEN
551 -TH
552 -TY

Juliet's Words

553 OH
554 ONE
555 TWO
556 THREE
557 FOUR
558 FIVE
559 SIX
560 SEVEN
561 EIGHT
562 NINE
563 TEN
564 ELEVEN
565 TWELVE
566 THIRTEEN
567 FOURTEEN
568 FIFTEEN
569 SIXTEEN
570 SEVENTEEN
571 EIGHTEEN
572 NINETEEN
573 TWENTY
574 THIRTY
575 FORTY
576 FIFTY
577 GOOD
578 MORNING
579 AFTERNOON
580 EVENING
581 THE
582 TIME
583 IS
584 A.M.
585 P.M.
586 O'CLOCK

Pause

587 PAUSE

Sound Effects

588 LASER
589 WHISTLE
590 PHASER
591 TRAIN
592 EXP
593 CROWD
594 TIC
595 TOC
596 HIGH-LOW TONE
597 LOW-HIGH TONE
598 HIGH TONE

Junior's Words

599 ALARM
600 AMATEUR
601 ANALOG
602 ARIZONA
603 AUTOPATCH
604 BACHELOR
605 BAD
606 BASE
607 BATTERY
608 BAY
609 BILLINGS
610 BOZEMAN
611 CANOE
612 CAPROCK
613 CENTRAL
614 CHARGING
615 CLOUDS
616 CLUB
617 COMMUNICATIONS
618 CONTROLLER
619 DIGITAL
620 EMPIRE
621 EVENT
622 FIELD
623 FLASH
624 FLOOD
625 FRIENDLY
626 GOLDEN
627 GREYCLIFF
628 HAM

629 HAMFEST
630 HARRISON
631 HOLLEY
632 HOME
633 INFORMATION
634 INLAND
635 INPUT
636 INSIDE
637 KOOTENAI
638 LINK
639 LITTLEROCK
640 MEDIUM
641 MEETING
642 MICA
643 MONITOR
644 MOUNTAIN
645 NET
646 OBED
647 OREGON
648 OUTSIDE
649 PEAK
650 POUND
651 PUMP
652 PYRAMID
653 RACES
654 RADIO
655 RATTLESNAKE
656 REMOTE
657 REPEATER
658 RIDGE
659 SANDRA
660 SCAN
661 SIDNEY
662 SKYWARN
663 SOCIETY
664 SPOKANE
665 STAR
666 STATE
667 SUNDANCE
668 SYSTEM
669 TACOMA
670 THIS
671 TIGER
672 TODAY
673 TOMORROW
674 TONIGHT
675 VALUE

676 VOLTAGE
 677 WASHINGTON
 678 WATCH
 679 WATER
 680 WELCOME
 681 WITH
 682 YAKIMA
 683 YELLOWHEAD
 684 YELLOWKNIFE
 685 ZED

***Internal Variable Words
 (don't use these)***

800 UNUSED
 801 START POLITE
 802 END POLITE
 803 END POLITE DO
 CMD
 804 DO DELAYED DIAL
 805 START DVR TIMER

User Variable Words

810 TIME
 811 HOUR (12 hr)
 812 HOUR (24 hr)
 813 MINUTE OF HOUR
 814 AM/PM
 815 DATE
 816 MONTH OF YEAR
 817 DAY OF MONTH
 818 YEAR
 819 DAY OF WEEK
 830 TIME (FEMALE)
 831 HOUR,F (12 hr)
 832 HOUR,F (24 hr)
 833 MINUTE,F
 834 AM/PM (FEMALE)
 835 MRN/AFT/EVE, F
 836 ANALOG 1
 837 ANALOG 2
 838 ANALOG 3
 839 ANALOG 4
 840 ANALOG 5
 841 ANALOG 1 HIGH
 842 ANALOG 2 HIGH
 843 ANALOG 3 HIGH

844 ANALOG 4 HIGH
 845 ANALOG 5 HIGH
 846 ANG 1 HIGH TIME
 847 ANG 2 HIGH TIME
 848 ANG 3 HIGH TIME
 849 ANG 4 HIGH TIME
 850 ANG 5 HIGH TIME
 851 ANALOG 1 LOW
 852 ANALOG 2 LOW
 853 ANALOG 3 LOW
 854 ANALOG 4 LOW
 855 ANALOG 5 LOW
 856 ANG 1 LOW TIME
 857 ANG 2 LOW TIME
 858 ANG 3 LOW TIME
 859 ANG 4 LOW TIME
 860 ANG 5 LOW TIME

Special Word Pairs:

Most of the following words need to be followed by another word number that specifies which one to do: which analog line to read, which command to execute, which time zone to use, etc. For example, to read analog 5 as an S-meter, you would want to speak word 920 followed by word 005. Analog lines 1..8 are on I/O board #1, 9..16 are on I/O board #2. 

861 xxx - read analog 1..16 as S-Meter. To obtain a current reading, must use an event trigger to clear the high value each time the COR goes active. For example "157 000 500" followed by "053 500 038" and "056 500 160 11" will reset the high value for analog line 1 whenever the COR for port 1 goes active. 

862 xxx - read analog 1..16 as a Direction: N, NE, E, SE, S, etc.

863 xxx - execute command xxx (up to command 900 or so, may not go all the way to 999). Will not happen until this word is actually spoken.

864 xxx - speak 24 hour time in male voice adding xxx hours. Can use to speak the time for any

time zone.
865 xxx - same as above in
female voice



Appendix C: CW Code Table

CW Code Table

CW	XX	.	CW	XX	.	CW	XX	.	CW	XX	.	CW	XX
0	00	.	A	10	.	K	20	.	U	30	.	SPACE	40
1	01	.	B	11	.	L	21	.	V	31	.	PAUSE	41
2	02	.	C	12	.	M	22	.	W	32	.	DVR 1	42
3	03	.	D	13	.	N	23	.	X	33	.	DVR 2	43
4	04	.	E	14	.	O	24	.	Y	34	.	DVR 3	44
5	05	.	F	15	.	P	25	.	Z	35	.		
6	06	.	G	16	.	Q	26	.	/	36	.		
7	07	.	H	17	.	R	27	.	0	37	.		
8	08	.	I	18	.	S	28	.	?	38	.		
9	09	.	J	19	.	T	29	.	AR	39	.		

Note: Sending the “CW” character 42, 43 or 44 actually plays one of the internal DVR messages.

Appendix D: Reset and Initialization

The terms "reset" and "initialization" refer to totally different things on the RLC-Club. The controller is "reset" when any of the following things happen:

- the power is turned off and back on
- the reset button on the motherboard is pressed and released
- Command 035 is executed

Resetting the controller does not cause you to lose any of your programming. It does restart all of the timers and a lot of other internal variables. If the controller is not doing what you think it should, try resetting it and see if things straighten out.

"Initialization" (sometimes called "re-initialization") resets all of the controller's internal settings back to the factory defaults. It does cause you to lose all of your programming. You will almost always have to initialize the controller when you install a new version of software, but rarely otherwise. If you are trying to learn to program the RLC-Club and you mess things up, you can use this to put everything back the way it is supposed to be. Initialization does not hurt the RLC-Club in any way - there is no EEPROM or anything to wear out. To reinitialize the RLC-Club, follow one of the two methods below:

Method #1: Press and hold the INIT button on the motherboard. Turn on the power. Wait for about 3 seconds (or longer). Release the INIT button.

Method #2: Turn the power on. Press and hold the INIT button. Press and release the RESET button. Wait at least 3 seconds. Release the INIT button.

If you are successful you will hear the message "I-N-I-T" out of the transmitter that is hooked to port 1 and see the message "All settings have been reset to factory defaults" on the serial terminal.

Appendix E: Not Currently Used

Appendix F: Programming with the Serial Port

Entering commands from the serial port works almost exactly the same way as with DTMF tones from a radio. The characters you enter on the keyboard are treated the same way as the digits on your radio keypad. Of course you can enter digits on the keyboard that you can not enter from a keypad, which gives you a little additional flexibility. Some of the things you can do from the keyboard that you can not do from a DTMF pad are:

- Back up. If you type a digit you did not mean to type, simply press the backspace key and delete it.
- Press the Enter key. This tells the controller to try to execute whatever you have typed so far. This is exactly the same as unkeying your radio to force a command to execute. When you have entered a command you can either enter an '!' or press <Enter> to make it execute.
- Store a bunch of commands in a file on your computer that you can upload without typing them again. See the section on using a serial upload file later in this appendix.

Example: I want to execute Command 009 to see which ports are connected together:

Over the air:

<Key radio> 009 <Unkey or press "D">

From the serial port:

<ENTER>

You will see the serial port prompt "DTMF>". This indicates that the characters you enter are being treated just as if they were entered by DTMF from a radio port

009 <Enter or press "D">

Example: I want to execute command 000 to connect ports 1 and 2 together:

Over the air:

<Key radio> 000 12 <Unkey or press "D">

From the serial port:

<ENTER>

000 12 <Enter or press "D">

Now try 009 (the first example) again. The crosspoint will show that ports 1 and 2 have been connected.

Voice responses to commands entered serially:

Normally, when you enter commands from the serial port, the voice responses go out port one. Since you also get responses on your computer screen, they really aren't needed in most cases, and can get annoying if you are doing a lot of programming. You can control whether or not you get voice responses to the commands you enter serially with Command 050. Using that command you can tell the RLC-3 to send the voice responses out any port (or more than one), or nowhere at all. To keep it from sending voice responses, enter "050 0" and press enter (you can also make that the first line of your upload files). To turn them back on, enter "050 01" and press enter.

If you are uploading a large file and you have the voice enabled, the voice might not be able to keep up with the commands that are being uploaded. If this happens and the voice gets 300 words or so behind, it will just skip those words so it is caught up and again try to keep up. You either have to upload very slowly or turn the voice off during uploads to avoid this.

Using a serial upload file:

A very convenient way to set up your controller if you have a computer is to type all of the commands that you use to set up your controller in a file using a word processor. Save the file in ASCII (plain text) format. Load your communications program and make sure you are talking to the RLC-3 by hitting return and checking for the "DTMF>" prompt. Now do an ASCII upload of the file that you saved all of your commands in (the controller won't know that you are doing an automatic upload, it will just think you are typing fast). Test the stuff you uploaded and if you want to make a change, go back to your editor and change it in the file. Now upload it again. By setting up your controller this way, you have a permanent record of everything you have done. If something ever gets messed up on the controller, all you have to do is initialize it (see Appendix D) and re-upload your file. Also, when you get a new version of software (which will almost always require you initialize), you will probably only have to make minor changes to your file to make it work with the new software version. This will definitely save you time in the long run. **There is no way to download all of the information in the controller to a file, so it is best to create the file as you go.** An example will illustrate the idea:

Using your favorite editor, enter the following (including the comments):

```
; this line is a comment - put a description of the file here
050 0 ;          Turn off the voice responses to serial commands
000 12 ;        Connect ports one and two
007 11 ;        Turn DTMF muting on for port 1
050 01 ;        Turn on voice responses to port 1
036 116 ;       Speak the word "Complete"
```

Save the file as RLC3.CMD or some other name of your choice.

Load your communications program.

Hit <Enter> and watch for the "DTMF>" prompt from the RLC-3. If you do not get it, check your cable and setup in your communications software.

You may want to tell your communications program to open a log file at this point.

It will come in handy for checking if any of the commands caused errors.
 Start an ASCII upload of your file.
 Wait until it finishes.
 Close the log file if you opened one.
 Try out your new settings. 009 will check the crosspoint and 008 will check the DTMF muting. Go back to your editor, make the required changes, and repeat the cycle.

Note about spaces in serial commands:

The controller totally ignores spaces in commands you enter from the serial port. Spaces are shown in the manual to make it easier to see the separate groups of characters; you may want to do this in your upload files as well. Spaces are never required, but you can put them wherever you want in your serial commands to make them easier to read.

Note about comments in serial upload files:

You can put as many comments in your upload files as you want. Anything following a ';' will be considered a comment and will be totally ignored by the controller. If you want a whole line to be a comment, just start it with a semicolon like this:

; this line is a comment.

If you want to put a comment after a command (on the same line), do it like this:

N000 11 ; this is a comment - this command makes port 1 a repeater.

It is highly recommended that you comment your upload files thoroughly. You will thank yourself when you go back months later and try to figure out what you were trying to do.

Note about capital letters:

By default the RLC-3 converts everything you type to a capital letter. This is because DTMF characters are always treated as capital letters and it avoids confusion. However, there may be a time when you would like to enter lower case letters, such as when you send serial messages with Command 032. At those times you can turn off the conversion to all capital letters with Command 060.

Note about download speeds:

If you download a file with more than a dozen commands or so in it, you may find that the responses from the RLC-3 get way behind, or even get lost with the message "Serial Output Queue just overflowed - it now looks empty". This is caused by the RLC-3 trying to send back all of the descriptive responses to the commands and not being able to send the responses as fast as it gets new commands. Eventually it runs out of buffer space and is forced to throw some of the responses away (it does not support software flow control yet). This does not affect the commands that are being sent to the RLC-3 in any way - just the responses that you see on the screen. If you

do not care about the responses, just let them get thrown away and forget it. There is no file size limit, just a limit on how fast you can send it to the controller. If you need to know what the responses are, you need to insert pauses while your communications program sends the commands to the RLC-3. Slowing the baud rate down will not help significantly, as that will slow down the responses just as much as the commands you are sending. There are several ways to do this:

- Tell the comm program to wait until it sees a new "DTMF>" prompt before sending the next line. To do this with the Windows 3.1 terminal program, go to the "Settings" menu, select "Text Transfers", then select flow control of "Line at a Time" and set a "Wait for Prompt String" of "DTMF>". Other comm programs will only let you set a single pacing character. You can try '>' (the last character in the "DTMF>" prompt). Waiting for a new prompt, or at least the last character of it, is the best method because it makes the comm program wait exactly as long as needed for the controller to finish the previous command.
- Change the ASCII transfer settings on your communications software to insert a 1.5 second delay after each line (longer for slow baud rates, shorter for fast baud rates). This will give the RLC-3 time to send the responses back without overflowing the queue. You may have to experiment to get enough delay to avoid overflowing without having to wait all day for the upload to finish.
- If you can't figure out how to do either of the above methods, you can try putting tilde characters at the end of each line in you upload file, like this:

```
N000 11 ;                comment ~~~
```

The tilde tells most comm programs to pause for a bit, usually 1/2 to 1 second.

Serial responses to commands entered from a radio:

Normally the commands that are entered from a radio do not cause anything to be sent out of the serial port; that is they are "suppressed". This lets you program the controller from the serial port while people are entering DTMF commands without them causing confusing messages to show up on the serial screen. If you want to see the commands that are being entered from the radios, you can turn "suppressed" serial off with command 060.

Very Long Serial Commands:

This section only applies to very long serial commands. If a line fits on the screen (80 characters wide), it isn't long enough to worry about. But there may be times when you make a very long command, maybe programming a voice message:

```
; make macro 500 speak one two three four five six seven eight
053          500 036 001 002 003 004 005 006 007 008 ;    comment
```

There is an internal line length limit; you will get an error message if you exceed it. If you do exceed it, check the following things: make sure there is a ';' right after the command, even if the comment is way off to the right. It is ok if the comment exceeds the line length limit - that won't

cause an error, it just won't let you backspace once you have exceeded the limit.

If you have checked to make sure the ';' comes right after the end of the command and you still get a message that the command is too long and overflows the buffer, remove some of the spaces in that command. If even that isn't enough to get it under the length limit, you will probably have to break it up into separate commands, possibly speaking the first half and last half of the message separately.

Appendix G: ASCII Chart

This chart may be helpful when programming serial messages with Command 034. Not all of the codes are included because not all of them are universally used and some don't print well.

032	073 I	114 r	156 £	197 †	238 €
033 !	074 J	115 s	157 ¥	198 ‡	239 ∩
034 "	075 K	116 t	158 ₣	199 †	240 ≡
035 #	076 L	117 u	159 ₣	200 †	241 ±
036 \$	077 M	118 v	160 á	201 †	242 ≥
037 %	078 N	119 w	161 í	202 †	243 ≤
038 &	079 O	120 x	162 ó	203 †	244 ∫
039 '	080 P	121 y	163 ú	204 †	245 ∫
040 (081 Q	122 z	164 ñ	205 =	246 ÷
041)	082 R	123 {	165 Ñ	206 †	247 ≈
042 *	083 S	124	166 ª	207 =	248 °
043 +	084 T	125 }	167 °	208 †	249 ·
044 ,	085 U	126 ~	168 ÿ	209 †	250 ·
045 -	086 V	128 Ç	169 ¸	210 †	251 √
046 .	087 W	129 ü	170 ¬	211 †	252 º
047 /	088 X	130 é	171 ½	212 †	253 ²
048 0	089 Y	131 â	172 ¼	213 †	254 ■
049 1	090 Z	132 ä	173 ÿ	214 †	255
050 2	091 [133 à	174 «	215 †	
051 3	092 \	134 å	175 »	216 †	
052 4	093]	135 ç	176 ☘	217 †	
053 5	094 ^	136 ê	177 ☘	218 †	
054 6	095 _	137 ë	178 ☘	219 ■	
055 7	096 `	138 è	179 †	220 ■	
056 8	097 a	139 ï	180 †	221 ■	
057 9	098 b	140 î	181 †	222 ■	
058 :	099 c	141 ì	182 †	223 ■	
059 ;	100 d	142 Ä	183 †	224 α	
060 <	101 e	143 Å	184 †	225 β	
061 =	102 f	144 É	185 †	226 Γ	
062 >	103 g	145 æ	186 †	227 π	
063 ?	104 h	146 Æ	187 †	228 Σ	
064 @	105 i	147 ô	188 †	229 σ	
065 A	106 j	148 ö	189 †	230 μ	
066 B	107 k	149 ò	190 †	231 τ	
067 C	108 l	150 û	191 †	232 Φ	
068 D	109 m	151 ù	192 †	233 Θ	
069 E	110 n	152 ÿ	193 †	234 Ω	
070 F	111 o	153 Ö	194 †	235 δ	
071 G	112 p	154 Ü	195 †	236 ∞	
072 H	113 q	155 ç	196 -	237 φ	

Appendix H: Using the LM335 Temperature Sensor

The RLC-Club supports the National Semiconductor LM335Z temperature sensor. The sensor converts temperature into voltage. This voltage is read by the controllers ADC (Analog-Digital Converter) which allows the controller to read a voltage. When using the LM335Z sensor, the sensor needs to be powered in order for the temperature to be read. Powering the sensor is accomplished by connecting the sensor to Analog inputs 1 or 2 or 3 .

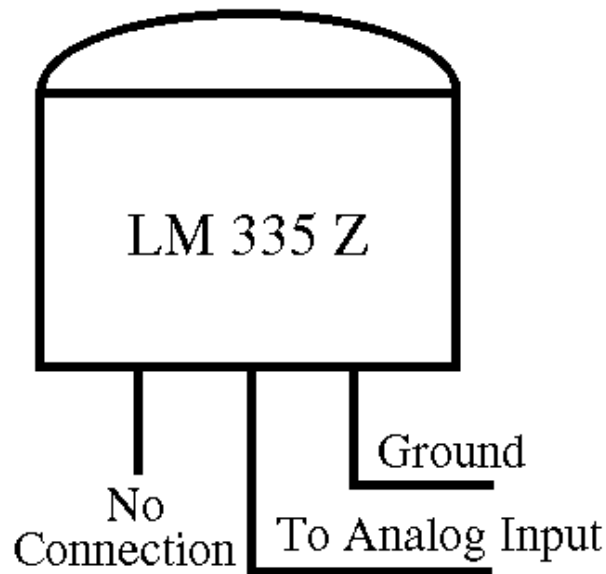

LM335Z Temperature Probe Connections Diagram

- If you have your temperature sensor hooked up backwards (+OUT switched with the -GND) you will read ~0.6 volts across the sensor.
- Verify the sensor is connected to an Analog input that has a powering resistor associated with the input. Analog 1,2,3 connector P4 pins 1,2,3 contain the powering resistor.
- Voltage meter reading at the sensor measure: $\text{Temperature Celsius} = (\text{voltage} * 100) - 273$

Appendix J: Hardware Reference Section

Important Connections:

RLC-Club Main Board

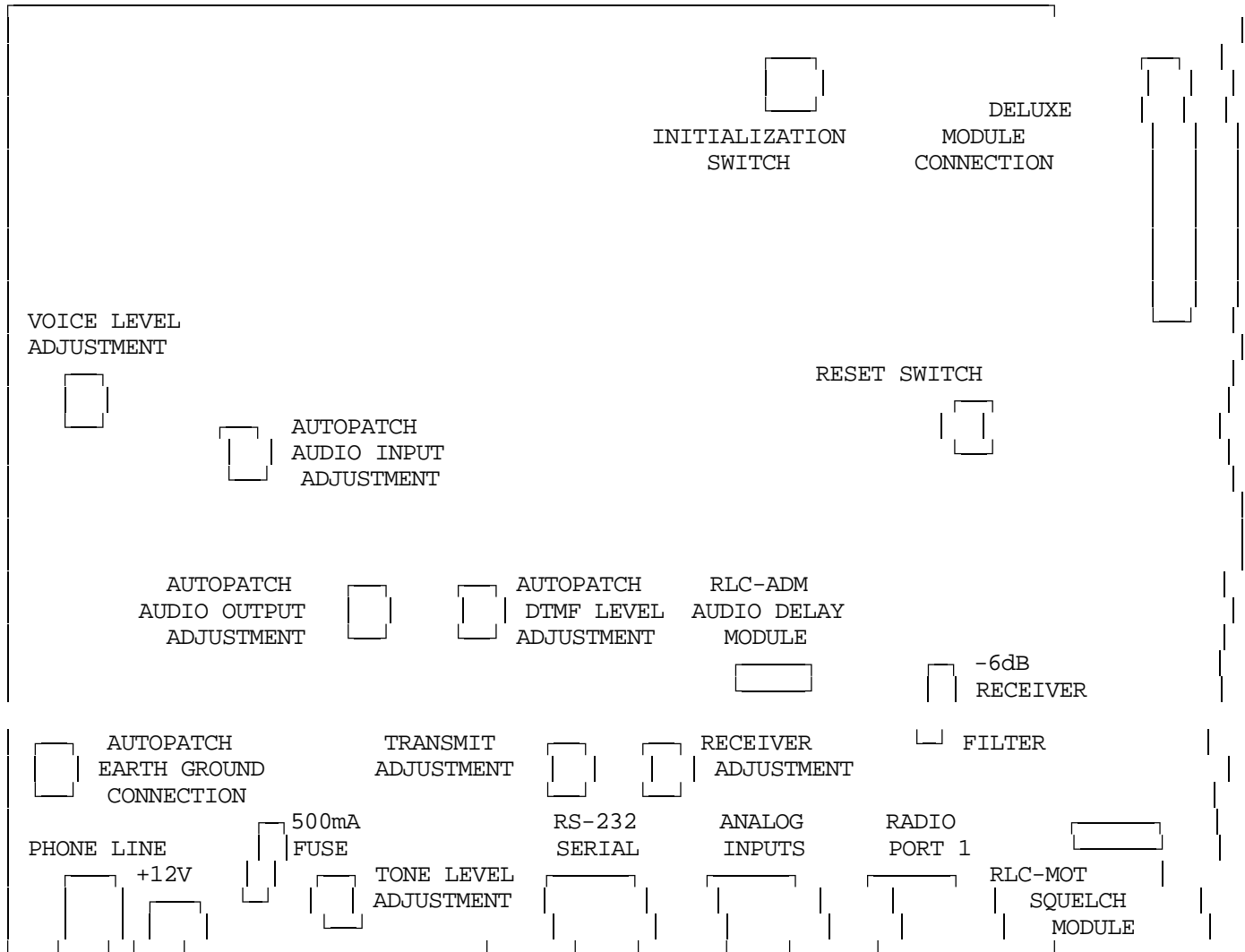

Adjustments:

Voice level adjustment allows you to vary the level of the voice synthesis generator. Adjust this level to 2 Khz. deviation. Refer to Chapter 1 for level adjustments.

Connections:

There are 3 supported options on the RLC-Club main board. These include the 'RLC-MOT' squelch module, 'RLC-ADM' digital audio delay module and the RLC-Club Deluxe module interface.

Initialize and Reset switches:

These switches are provided to allows the manual resetting and initialization of the controller. See Appendix D for instructions about how to perform the initialization.

RLC-Club Deluxe Module

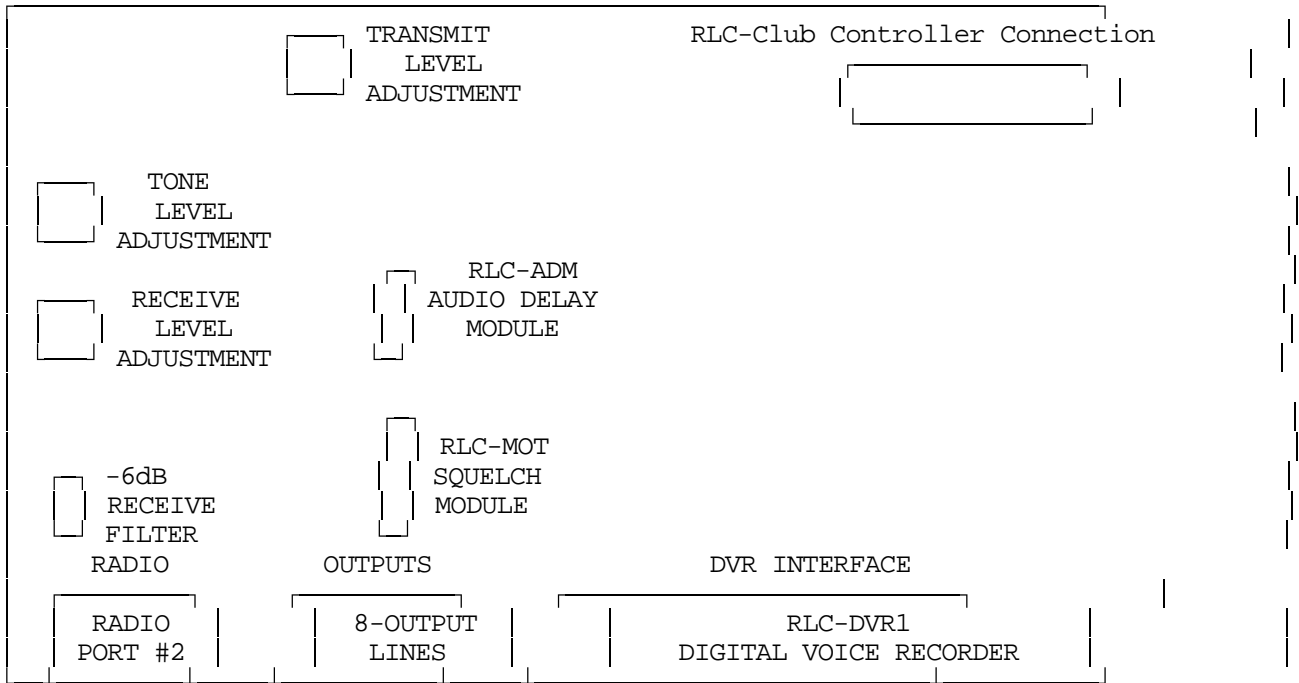

Connections:

There are 3 supported options on the RLC-Club Deluxe board. These include the 'RLC-MOT' squelch module, 'RLC-ADM' digital audio delay module and the RLC-DVR1 voice mail advanced Digital Voice Recorder system.

Other System Support:

The RLC-Club Deluxe interface supports the RLC-DVR1 large voice mail digital voice recorder system. This interface incorporates a complete voice mail and message service to the controller. The interfaces audio data is stored on 30 pin SIMM dynamic RAM modules. The interface returns 131 seconds of storage per 1 megabyte of DRAM. The minimum memory is 2 megs. with a maximum storage of 16 megs. Contact Link Communications, Inc. for more information.

Bill of Materials

RLC-Club Controller, Revision: A

Item	Quantity	Reference	Part	Description
1	1	BT1	3VLITH	Digi-Key # P195-ND
2	5	C1,C16,C17,C18,C2	0.22uF	0.2"LS, AXIAL
3	3	C3,C13,C15	4.7uF	0.1"LS, ELECT, 20V
3a	5	C4,C29,C30,C31,C32	4.7uF	0.1"LS, TANTALIUM, 20V
4	15	C6,C7,C9,C10,C26,C44,C45, C46,C47,C48,C49,C50,C51, C52,C53	0.1uF	0.2"LS, AXIAL
5	3	C8,C27,C28	22pF	0.1"LS, CER OR AXIAL
6	1	C12	200uF	0.2"LS, ELECT., 50V
7	1	C5	100pF	0.2"LS, AXIAL
8	4	C14,C25,C37,C40,C43	1uF	0.1"LS, ELECT, 20V
8a	1	C43	1uF	0.1"LS, TANTALIUM
9	9	C20,C21,C22,C23,C24,C33, C34,C35,C36	470pF	0.2"LS, AXIAL
10	2	C38,C41	0.0022uF	0.2"LS, AXIAL
11	2	C39,C42	0.0047uF	0.2"LS, AXIAL
12	2	D1,D2	1N750A	0.4"LS, DIODE
13	1	D3	1N4004	0.5"LS, DIODE
14	3	D7a,D7b,D7c	PL501-4R-D	LED DISPLAY MOUSER #512-MV60539.MPA8A
15	1	F1, 2 FUSE CLIPS	CLIPS	5mm CLIPS, MOUSER #44FH052
16	1	F1	500mA	5mm FAST BLOW FUSE

Bill of Materials Cont...

Item	Quantity	Reference	Part	Description
17	2	F3,F2	750mA	PICO FUSE,MOUSER#5761-51750
18	1	G1	KEY8191	SCREW LUG
19	1	J1	6 PIN	6 PIN MALE HEADER
19a	1	J1	JUMPER	SHORTING BLOCK
20	1	J2	4 PIN	4 PIN MALE HEADER
20a	1	J2	JUMPER	SHORTING BLOCK
21	4	J3,J7,J8,J9	2 PIN	2 PIN MALE HEADER
21a	4	J3,J7,J8,J9	JUMPER	SHORTING BLOCK
22	1	J4	HEADER	26 PIN SHROUD HEADER
23	1	J5	RJ-11	AMP #520250-2
24	1	J6	HEADER	NO-LOAD
25	1	L1	10uH	INDUCTOR, 0.5"LS
26	3	P1,P3,P4	DB9	DB-09, RAF
27	1	P2	POWER	2.5mm, PWR CONNECTOR
28	1	Q1	2N7000	TO-92 2N-7000 MOSFET
29	10	R1,R2,R5,R8,R28,R31,R36, R37,R49,R65	1K	RESISTOR, 1%, 0.25W
30	4	R3,R4,R24,R42	5.1K	RESISTOR, 1%, 0.25W
31	6	R12,R13,R16,R17,R59,R62	100K	RESISTOR, 1%, 0.25W
32	2	R6,R30	100K	VAR.RESISTOR
33	6	R21,R22,R23,R34,R39,R67	47K	RESISTOR, 1%, 0.25W
34	2	R7,R18	47K	RESISTOR, 6 PIN, SIP
35	2	R9,R35	200K	VAR.RESISTOR

Bill of Materials Cont...

Item	Quantity	Reference		Part
Description				
36	11	R10,R19,R20,R26,R27,R29	10K	RESISTOR, 1%, 0.25W
		R43,R44,R55,R63,R66		
36a	2	R25,R56	10K	VAR.RESISTOR
37	3	R45,R46,R47	10K	RESISTOR, 10 PIN,SIP
38	1	R11	680	RESISTOR, 1%, 0.25W
39	2	R14,R15	470K	RESISTOR, 1%, 0.25W
40	2	R32,R33	10	RESISTOR, 1%, 0.25W
41	1	R38	270	RESISTOR, 1%, 0.25W
42	1	R40	10M	RESISTOR, 1%, 0.25W
43	1	R41	330K	RESISTOR, 1%, 0.25W
44	1	R48	2.4K	RESISTOR, 6 PIN, SIP
45	3	R51,R52,R53	510	RESISTOR, 1%, 0.25W
46	1	R50	510	RESISTOR, 10 PIN,SIP
47	1	R54	40.2K	RESISTOR, 1%, 0.25W
48	4	R57,R58,R60,R61	12K	RESISTOR, 1%, 0.25W
49	1	R64	50K	VAR.RESISTOR
50	2	S1,S2	INIT	SWITCH, KEYBOARD
51	1	T1	XE0017	XECOM DAA
52	1	T2	600:10K	AUDIO TRANSFORMER (MOUSER #42-TL-019)
53	2	U1,U26	LMC660CN	AUDIO OP-AMP (LINK)
53a	2	U1,U26	14 PIN	DUAL LEAF SOCKET

Bill of Materials Cont...

Item	Quantity	Reference	Part	Description
54	1	U2	M-8870	DTMF DECODER (LINK)
54a	1	U2	18 PIN	DUAL LEAF SOCKET
55	1	U3	LM7805	TO-220 REGULATOR
55a	1	6-32" SCREW	SCREW	6-32" PHILLIPS SCREW
56	3	U4,U5,U6	74HC4066	AUDIO SWITCH (LINK)
56a	3	U4,U5,U6	14 PIN	DUAL LEAF SOCKET
57	1	U7	M-8880	DTMF TRANSIEVER (LINK)
57a	1	U7	20 PIN	DUAL LEAF SOCKET
58	1	U8	74HC04	CMOS INVERTOR (LINK)
58a	1	U8	14 PIN	DUAL LEAF SOCKET
59	1	U10	P3403AB	TECCOR SIDACTOR
60	1	U11	MC34072P	CMOS OP-AMP (LINK)
60a	1	U11	8 PIN	DUAL LEAF SOCKET
61	1	U12	DS1286	CLOCK CHIP (LINK)
61a	1	U12	28 PIN	MACHINED SOCKET
62	1	U13	TSP53C30	VOICE SYNTH. (LINK)
62a	1	U13	28 PIN	0.7" DUAL LEAF SOCKET
63	2	U14,U15	681000BLP	128K RAM CHIP (LINK)
63a	2	U14,U15	32 PIN	DUAL LEAF SOCKET
64	1	U16	68HC16Z1	MICROPROCESSOR (LINK)
64a	1	U16	132 PIN	AMP# 821949-5 SOCKET
64b	1	U16	COVER	AMP# 82-1942-1 COVER
65	1	U17	DS1221	BACK-UP CHIP (LINK)
65a	1	U17	16 PIN	DUAL LEAF SOCKET
66	1	U18	MAX232CPE	RS-232 SERIAL CHIP (LINK)
66a	1	U18	16 PIN	DUAL LEAF SOCKET
67	3	U19,U20,U21	74HC574	LINE DRIVER (LINK)
67a	3	U19,U20,U21	20 PIN	DUAL LEAF SOCKET

Bill of Materials Cont...

Item	Quantity	Reference	Part	Description
68	1	U22	AD557JN	DAC TONE CHIP (LINK)
68a	1	U22	16 PIN	DUAL LEAF SOCKET
69	1	U23	74HC138	3-8 SELECTOR (LINK)
69a	1	U23	16 PIN	DUAL LEAF SOCKET
70	1	U24	DS1232	DALLAS RESET CHIP
(LINK)				
70a	1	U24	8 PIN	DUAL LEAF SOCKET
71	1	U25	27C040	512Kx8 EPROM (LINK)
71a	1	U25	32 PIN	DUAL LEAF SOCKET
72	1	U9	M-949-01	LINE SENSE, TELETONE
73	1	Y1	3.5795Mhz	CRYSTAL HC-49U
74	1	Y2	3.2768Mhz	CRYSTAL HC-49U
75	1	Y3	32.768Khz	CRYSTAL TUNING FORK
76	1	PC1	PC BOARD	4 LAYER PC BOARD (LINK)

Bill of Materials

RLC-Club Deluxe, Revision: A

Item	Quantity	Reference	Part	Description
1	1	C1	0.22uF	0.2"LS, AXIAL
2	3	C3,C4,C6	4.7uF	0.1"LS, ELECT, 20V
3	7	C7,C8,C18,C19,C20,C21, C22	0.1uF	0.2"LS, AXIAL
4	5	C9,C10,C11,C12,C13	470pF	0.2"LS, AXIAL
5	1	C5	100pF	0.2"LS, AXIAL
6	1	C14	0.0022uF	0.2"LS, AXIAL
7	1	C15	0.0047uF	0.2"LS, AXIAL
8	2	C16,C17	1uF	0.1"LS, TANTALIUM, 20V
9	2	D1,D2	1N750A	0.4"LS, DIODE
10	1	J1	6 PIN	6 PIN MALE HEADER
10a	1	J1	JUMPER	SHORTING BLOCK
11	1	J2	4 PIN	4 PIN MALE HEADER
11a	1	J2	JUMPER	SHORTING BLOCK
12	1	J3	2 PIN	2 PIN MALE HEADER
12a	1	J3	JUMPER	SHORTING BLOCK
13	1	J4	HEADER	26 PIN SHROUD HEADER
14	1	P1	DB25	DB-25, RAF
15	2	P2,P3	DB9	DB-09, RAF
16	1	Q1	2N7000	TO-92 2N7000 MOSFET
17	7	R1,R2,R5,R10,R18,R27,R28	1K	RESISTOR, 1%, 0.25W
18	2	R3,R4	5.1K	RESISTOR, 1%, 0.25W

Bill of Materials Cont...

Item	Quantity	Reference	Part	Description
19	3	R20,R21,R26	100K	RESISTOR, 1%, 0.25W
20	1	R6	100K	VAR.RESISTOR
21	6	R7,R8,R12,R14,R15,R17	10K	RESISTOR, 1%, 0.25W
22	2	R16,R22	47K	RESISTOR, 1%, 0.25W
23	1	R9	47K	RESISTOR, 6 PIN, SIP
24	1	R11	200K	VAR.RESISTOR
25	1	R13	680	RESISTOR, 1%, 0.25W
26	1	R19	470K	RESISTOR, 1%, 0.25W
27	1	R23	50K	VAR.RESISTOR
28	2	R24,R25	12K	RESISTOR, 1%, 0.25W
29	1	U1	74HC244	BUSS INTERFACE (LINK)
29a	1	U1	20 PIN	DUAL LEAF SOCKET
30	3	U2,U10,U12	74HC574	LINE DRIVER (LINK)
30a	3	U2,U10,U12	20 PIN	DUAL LEAF SOCKET
31	1	U3	M-8870	DTMF DECODER (LINK)
31a	1	U3	18 PIN	DUAL LEAF SOCKET
32	1	U4	MC34072P	CMOS OP-AMP (LINK)
32a	1	U4	8 PIN	DUAL LEAF SOCKET
33	2	U5,U6	74HC4066	AUDIO SWITCH (LINK)
33a	2	U5,U6	14 PIN	DUAL LEAF SOCKET
34	1	U7	AD557JN	DAC GENERATOR (LINK)
34a	1	U7	16 PIN	DUAL LEAF SOCKET
35	1	U8	LMC660CN	QUAD OP-AMP (LINK)
35a	1	U8	14 PIN	DUAL LEAF SOCKET

Bill of Materials Cont...

Item	Quantity	Reference	Part	Description
36	1	U9	74HC138	3-8 DECODER (LINK)
36a	1	U9	16 PIN	DUAL LEAF SOCKET
37	1	U11	UD2597A	OUTPUT DRIVER (LINK)
37a	1	U11	20 PIN	DUAL LEAF SOCKET
38	1	Y1	3.579MHZ	CRYSTAL, HC-49U
39	1	PC1	PC BOARD	4 LAYER PC BOARD (LINK)
40	1	CABLE1	7" Cable	HEADER CABLE (LINK)

Component Layouts and Schematic Diagrams